

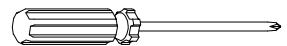

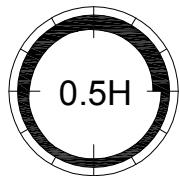

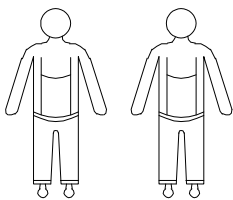
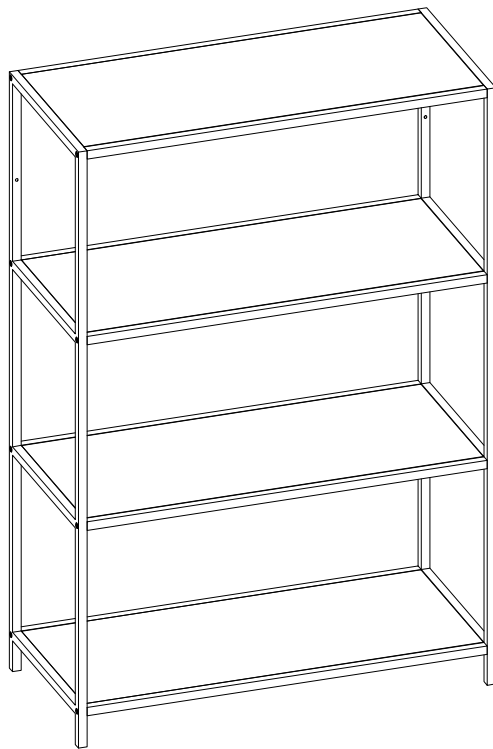
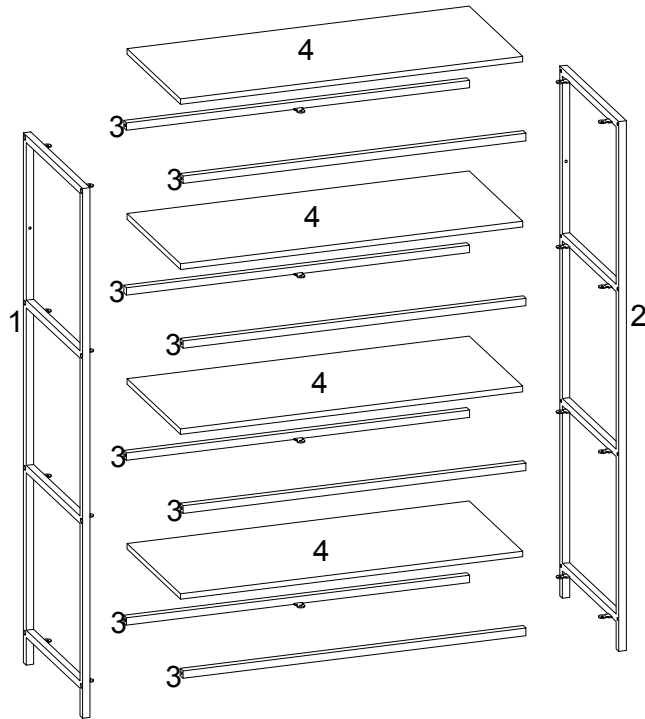

# Seaford

---



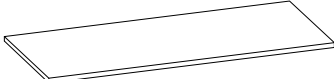

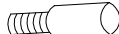

<p>1</p>  <p>1PC</p>	<p>2</p>  <p>1PC</p>
<p>3</p>  <p>8PCS</p>	<p>4</p>  <p>4PCS</p>

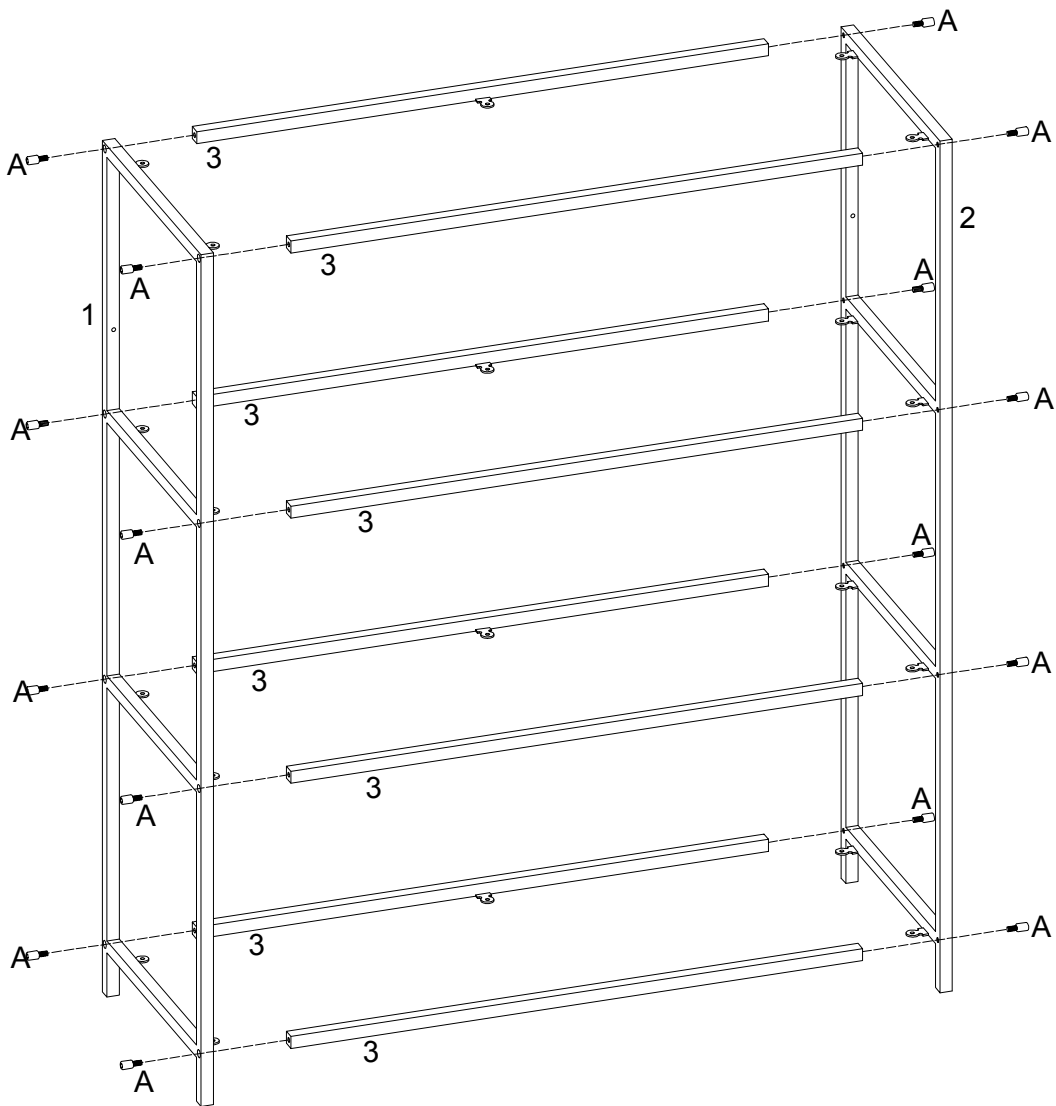
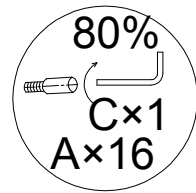
<p>A</p> <p>M6×15mm</p>  <p>16PCS</p>	<p>B</p> <p>M4×12mm</p>  <p>24PCS</p>	<p>C</p> <p>4mm</p>  <p>1PC</p>
--	--	--



<p><b>A</b></p> <p>M6×15mm</p>  <p>16PCS</p>	<p><b>C</b></p> <p>4mm</p>  <p>1PC</p>
---	---

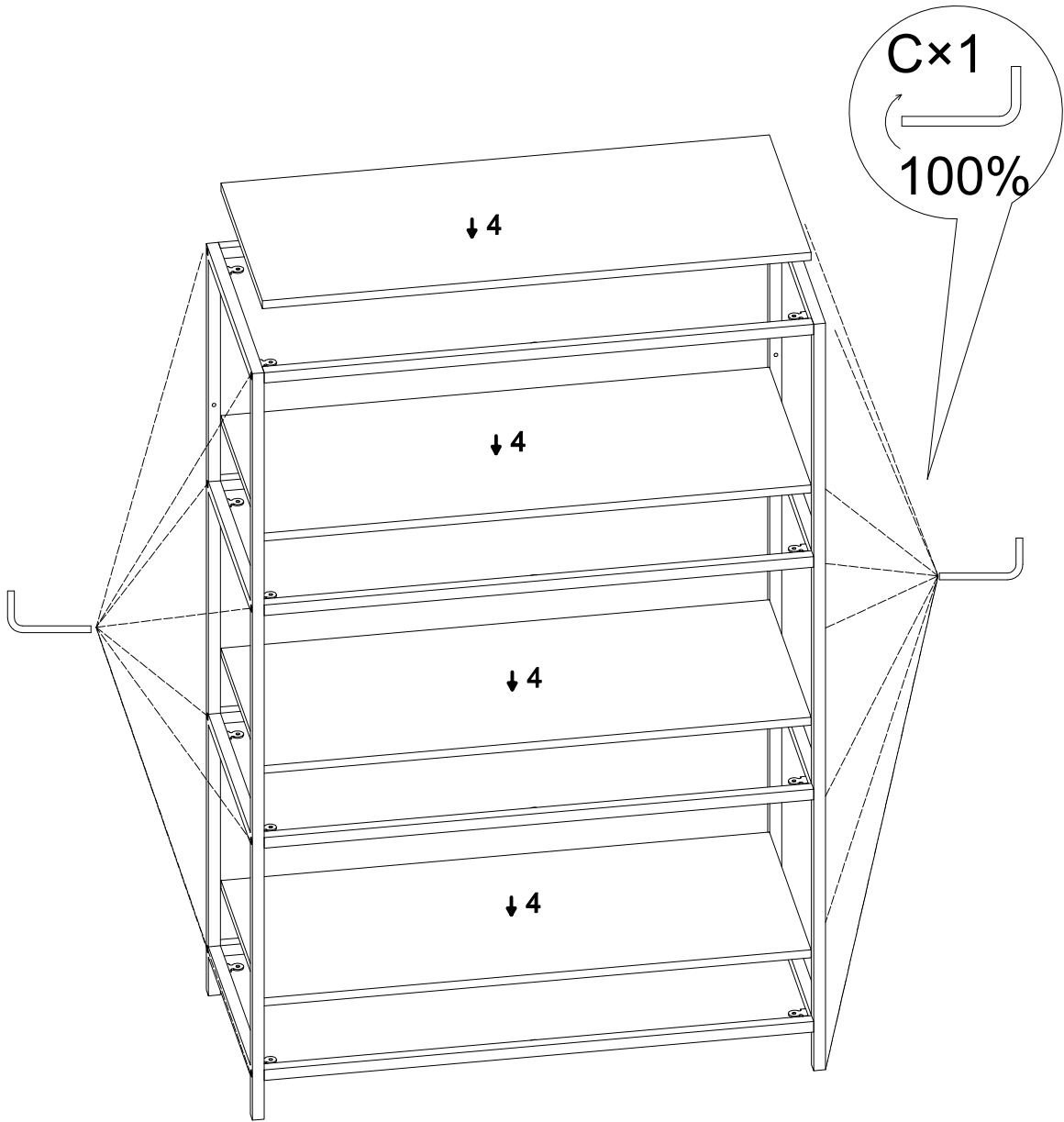

!  $XX=YY$

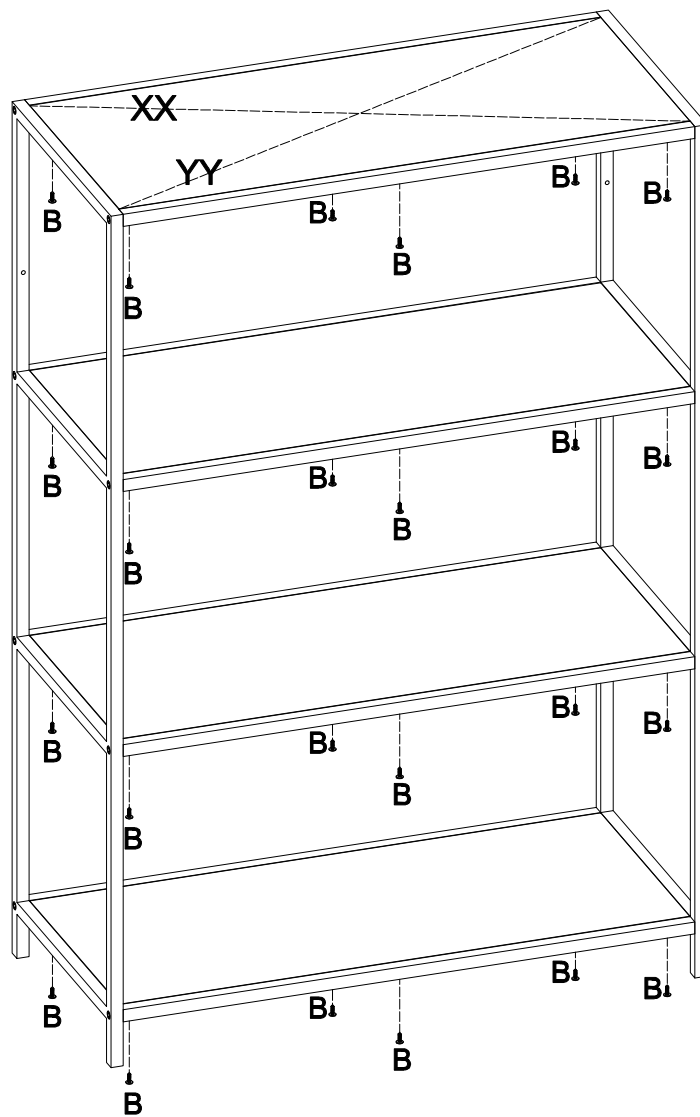

**B**  
M4×12mm  
  
24PCS

