

LKZ_80236

Modellname / Model name / Nom du modèle / Modellnamn / Nome modello / Název modelu / Modelnaam / Ime modela / Numéro Modelo / Modell neve / Название модели / Názov modelu / Ime modela / Denumire model / Наименование на модела / Nazwa modelu

SynnaX

Modellnummer / Number / Numéro du modèle / Numero / Номер на модела / modello / Číslo modelu / Modell száma / Éíslo modelu / Številka modela / Număr model / Broj modela / Modelnummer / Numer modelu

2134-131-84

Typ / Tipo / Tipus / Туп / Тип / Тiр

131

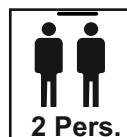
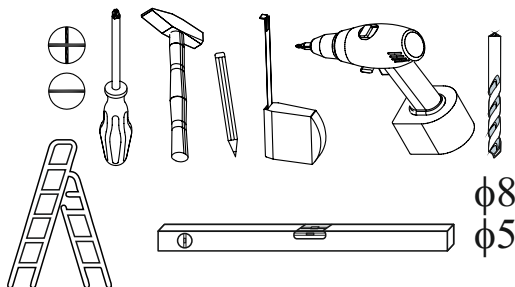
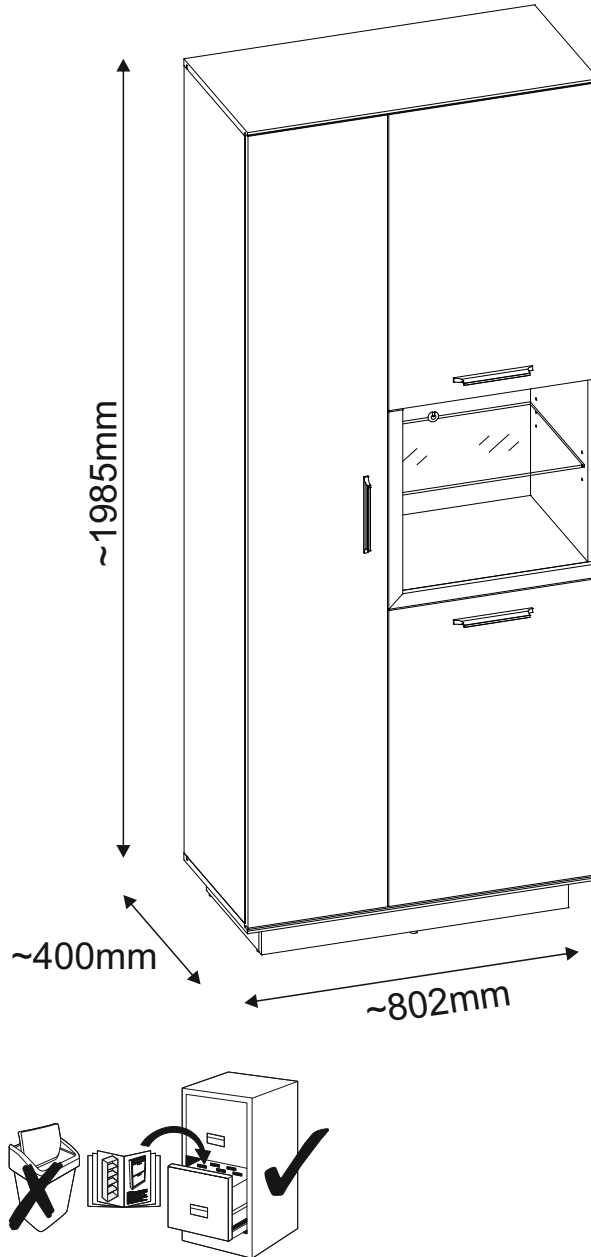
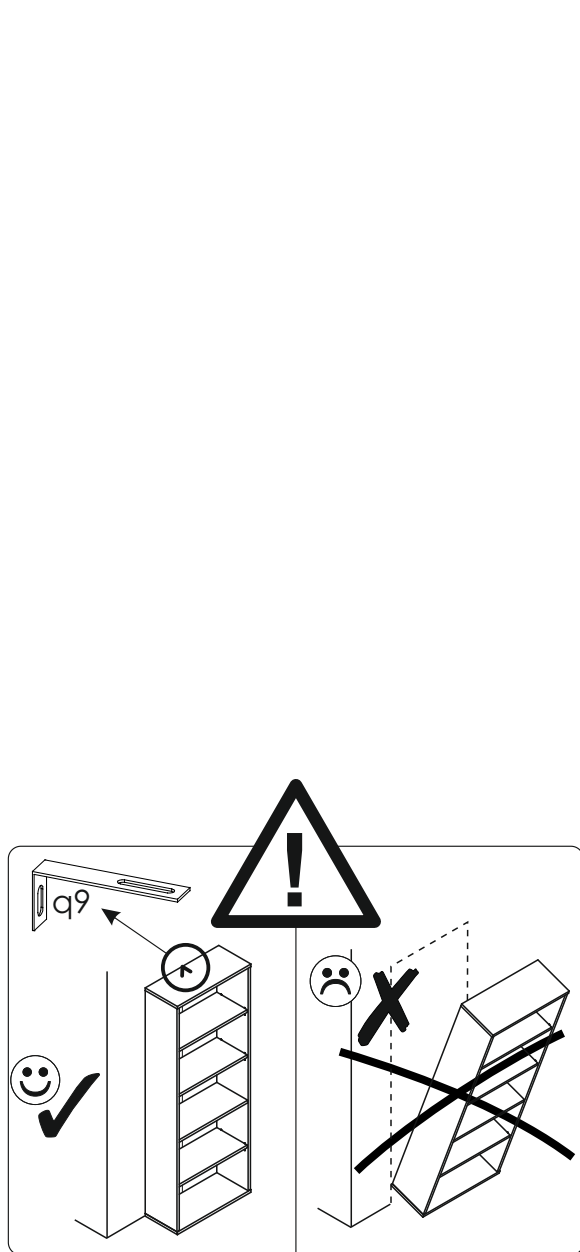
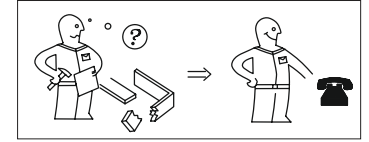
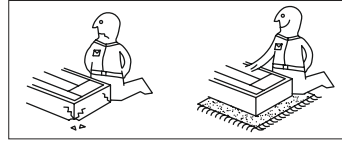
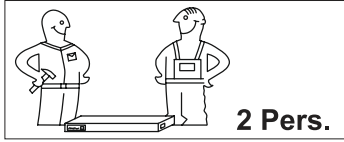

festziehen / tighten / Затягнете / serrer / stringere / utáhnout / vasttrekken / zategnuti / strángere / zwiázac / zacsináç / szorosan meghúzni / pevne dotiahnuť / trdno pritegniti / затянуть / dra át



eindrücken / press in / enfoncer / wcisnaç / ribattere / zatlaçit / Вкарайте / indrukken / benyomni / stlaçit / vtisniti / tryck in / introducere prin apásare / вдавить



ausmessen / measure / mesurer / misurare / opmeten / izmeriti / miara / kimérni / izmeriti / mäsurare / измерить / změřit / Измерете / mät upp / zmierzuç



drücken / press / presser / stisknout / Натиснете / vtisniti / nasinac / drukken / pritisnuti / nacsinac / pritisniti / нажать / (meg)nyomni / apasare / tryck fast / nacsináç



einschlagen / hammer in / beverni / sla in / frapper au marteau / infossare / Zabit* / zarazit / Набийте / zabiti / wbiç / introducere prin bátaie / забить / zatluoc



Drehen - wenden / przekręciç - odwróciç / Keren - omdraaien / Girare - Ruotare / Okrenuti - ubrnuti / Retourner - renverser / Turn over - tum around / Otoçte - obratite / Závъртете - обърнете / Obrnite list / întoarçei - rotiți / Vrid runt - vänd / прокрутить - повернуть / otoçit - obrátit / elforgatni - megfordítani

LKZ 80236

Modellname / Model name / Nom du modèle / Modellnamn
Nome modello / Název modelu / Modelnaam / Ime modela
Numéro Modelo / Modell neve / Название модели /
Názov modelu / Ime modela / Denumire model /
Наименование на модела / Nazwa modelu

Synnax

Modellnummer / Number / Numéro du modèle
Numero / Номер на модела / modello
Číslo modelu / Modell száma / Èislo modelu
Številka modela / Număr model / Broj modela
Modelnummer / Numer modelu

2134-131-84

Type / Tipo / Típus / Typ / Тип / Tip

131

D **Unser Direktservice für Beschlagteile**
Sollte Ihnen ein Beschlagteil fehlen, können Sie diese Servicekarte direkt an die untenstehende Adresse mailen. Wir können allerdings nur Beschlagteile auf diesem Wege verschicken. Sollten Sie eine andere Beanstandung an Ihrem Möbelstück haben, so wenden Sie sich bitte direkt an Ihr Möbelhaus.

GB **Our direct order service for fitting**
If a fitting part is missing, you can e-mail this service card directly to the address below. However, we can only send fitting parts in this way. If you have any other cause for complaint concerning your item of furniture, please contact your furniture store directly.

CZ **Naše přímé služby pro kování**
Chybí-li vám nějaký díl z kování, můžete tuto servisní kartu odeslat e-mailem přímo na níže uvedenou adresu. Touto cestou však můžeme zoslat jen díly kování. Pokud byste reklamovali jiný díl nábytku, obraťte se přímo na svého prodejce nábytku.

F **Bien étudier la notice de montage**
S'il vous manque une ferrure, veuillez envoyer directement la présente carte service à l'adresse e-mail indiquée ci-dessous. Cependant, ceci nous permet uniquement d'envoyer des ferrures. Pour tout autre type de réclamation concernant votre meuble, veuillez contacter directement votre magasin d'ameublement.

I **Il nostro servizio diretto per l'ordine della ferramenta**
Qualora Vi dovesse mancare un pezzo di fissaggio, allora Vi preghiamo di inviare questa carta di servizio immediatamente all'indirizzo sottostante. Possiamo inviare i pezzi di fissaggio solamente per mezzo di questo procedimento. Qualora dovete avere qualche altra reclamazione in merito al mobile, allora Vi preghiamo di rivolgerVi direttamente al Vostro Negozio di mobili.

BG **Нашата директна услуга за обкова**
Ако липсват части от комплекта, попълнете настоящата сервисна карта и ни я изпратете на e-mail адреса, посочен по-долу. По този начин можем да доставяме само липсващи елементи от обкова. Ако установите други дефекти по мебелите, Ви съветваме да се обърнете към мебелната къща/магазин, от който сте закупили стоката.

NL **Onze directservice voor losse onderdelen**
Wanneer er een onderdeel ontbreekt, kunt u deze servicekaart direct aan onderstaand e-mailadres sturen. Wij kunnen langs deze weg echter alleen beslagdelen versturen. Mocht u een ander probleem aan uw meubel hebben, verzoeken wij u contact op te nemen met uw meubeldealer.

PL **Nasz bezpośredni serwis części montażowych**
Jeżeli brakuje części koniecznych do montażu, prosimy o przesłanie nam niniejszej karty serwisowej na niżej podany adres e-mailowy. W ten sposób możemy przesłać Państwu tylko brakujące części. W przypadku innych reklamacji dotyczących mebla, prosimy zgłosić się do salonu meblowego, w którym został dokonany zakup.

HR **Servis za okove**
U slučaju da nedostaje neki od dijelova molimo vas da na dolje navedenu mail adresu pošaljete ovaj servisni obrazac. Na ovaj način mogu se dostaviti samo okovi. U slučaju da imate dodatne prigovore vezane uz komad namještaja molimo vas da se obratite izravno trgovini namještaja gdje je isti kupljen.

HU **Direktszolgáltatunk vasalatk esetén**
Ha hiányzik egy vasalat, ezt a kártyát közvetlenül elküldheti az alább található címre. Azonban csakis vasalatoskat tudunk így küldeni. Amennyiben másfajta reklamáció áll fenn bútordarabját illetően, forduljon közvetlenül a bútórészhez.

SK **Náš priamy servis pre časti kovania**
Ak by Vám chýbala nejaká časť kovania, môžete poslať túto servisnú kartu poslať e-mailom na nižšie uvedenú adresu. Diely kovania vieme poslať iba týmto spôsobom. Ak by ste mali inú reklamáciu ohľadom Vášho nábytku, obráťte sa priamo na Vašu predajňu nábytku.

SLO **Naše direktno uslužne storitve za okovje**
Če vam manjka kakšno okovje, lahko to servisno kartico pošljete po e-pošti direktno na spodnji naslov. Po tej poti vam lahko pošljemo samo okovje. Če želite reklamirati kakšen drug del pohištva, se obrnite neposredno na vašo trgovino pohištva.

RO **Service-ul nostru direct pentru feronerie**
În cazul în care vă lipsește o piesă de feronerie puteți să trimiteți direct acest card de service prin e-mail la adresa de mai jos. Noi nu putem expedia piese de feronerie decât pe această cale. Dacă aveți o altă reclamație referitoare la piesa de mobilier, atunci vă rugăm să vă adresați direct la magazinul dvs. de mobilă.

RUS **Наш прямой сервис для поставок фурнитуры**
Если окажется, что Вам не хватает того или иного элемента фурнитуры, Вы можете отправить сервисную карту по факсу непосредственно на нижеприведенный адрес электронной почты. Однако, таким образом мы можем пересылать лишь фурнитуру. Если же у Вас возникнут иные претензии относительно приобретенной мебели, пожалуйста, обращайтесь непосредственно в организацию, осуществившую продажу.

S **Vår direktservice för beslagsdelar**
Om du saknar en beslagsdel kan du skicka detta servicekort direkt till e-postadressen som anges nedan. Tänk på att detta är den enda möjligheten att skicka beslagsdelar till dig. Om du vill reklamera din möbel av en annan anledning måste du kontakta ditt möbelhus direkt.

ES **Nuestro servicio directo para accesorios**
Si le falta algún accesorio, puede enviar esta tarjeta de servicio directamente a la siguiente dirección. No obstante, por este método solo podemos enviar accesorios. Si tiene alguna otra objeción sobre su mueble, consulte directamente con su mueblería.

TR **Donatılar için doğrudan servisimiz**
Bir donatınız eksikse bu servis kartını doğrudan aşağıda bulunan adrese doğrudan mail yazabilirsiniz. Sadece bu yolla donatıları gönderebiliriz. Mobilyanızda başka şikayetleriniz varsa lütfen doğrudan mobilya satıcınıza danışın.

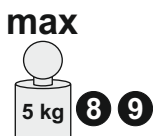
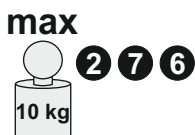
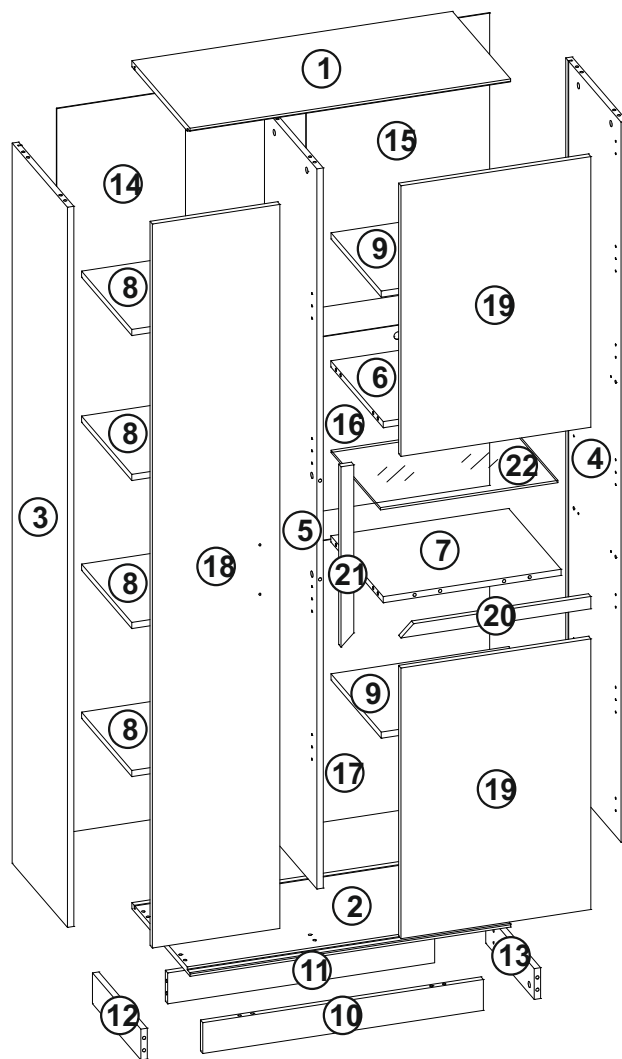

Grund der Beanstandung / Cause for complaint:

Möbelhaus / Furniture store:

Kunde / Customer:

Telefon / Telephone:

PLZ / Postcode:

Ort / City:

Str.+Nr. / Street address

@E-Mail:

LKZ 80236

Modellname / Model name / Nom du modèle / Modellnamn
Nome modello / Název modelu / Modelnaam / Ime modela
Numéro Modelo / Modell neve / Название модели /
Názov modelu / Ime modela / Denumire model /
Наименование на модела / Nazwa modelu

Synnax

Modellnummer / Number / Numéro du modèle
Numero / Номер на модела / modello
Číslo modelu / Modell száma / Èislo modelu
Številka modela / Număr model / Broj modela
Modelnummer / Numer modelu

2134-131-84

Type / Tipo / Tipus / Typ / Тип / Tip

131

D Unser Direktservice für Beschlagteile
Sollte Ihnen ein Beschlagteil fehlen, können Sie diese Servicekarte direkt an die untenstehende Adresse mailen. Wir können allerdings nur Beschlagteile auf diesem Wege verschicken. Sollten Sie eine andere Beanstandung an Ihrem Möbelstück haben, so wenden Sie sich bitte direkt an Ihr Möbelhaus.

GB Our direct order service for fitting
If a fitting part is missing, you can e-mail this service card directly to the address below. However, we can only send fitting parts in this way. If you have any other cause for complaint concerning your item of furniture, please contact your furniture store directly.

CZ Naše přímé služby pro kování
Chybí-li vám nějaký díl z kování, můžete tuto servisní kartu odeslat e-mailem přímo na níže uvedenou adresu. Touto cestou však můžeme rozeslat jen díly kování. Pokud byste reklamovali jiný díl nábytku, obraťte se přímo na svého prodejce nábytku.

F Bien étudier la notice de montage
S'il vous manque une ferrure, veuillez envoyer directement la présente carte service à l'adresse e-mail indiquée ci-dessous. Cependant, ceci nous permet uniquement d'envoyer des ferrures. Pour tout autre type de réclamation concernant votre meuble, veuillez contacter directement votre magasin d'ameublement.

I Il nostro servizio diretto per l'ordine della ferramenta
Qualora Vi dovesse mancare un pezzo di fissaggio, allora Vi preghiamo di inviare questa carta di servizio immediatamente all'indirizzo sottostante. Possiamo inviare i pezzi di fissaggio solamente per mezzo di questo procedimento. Qualora dovreste avere qualche altra reclamazione in merito al mobile, allora Vi preghiamo di rivolgerVi direttamente al Vostro Negozio di mobili.

BG Нашата директна услуга за обкови
Ако липсват части от комплекта, попълнете настоящата сервисна карта и ни я изпратете на e-mail адреса, посочен по-долу. По този начин можем да доставяме само липсващи елементи от обкова. Ако установите други дефекти по мебелите, Ви съветваме да се обърнете към мебелната къща/магазин, от който сте закупили стоката.

NL Onze directservice voor losse onderdelen
Wanneer er een onderdeel ontbreekt, kunt u deze servicekaart direct aan onderstaand e-mailadres sturen. Wij kunnen langs deze weg echter alleen beslagdelen versturen. Mocht u een ander probleem aan uw meubel hebben, verzoeken wij u contact op te nemen met uw meubeldealer.

PL Nasz bezpośredni serwis części montażowych
Jeżeli brakuje części koniecznych do montażu, prosimy o przesłanie nam niniejszej karty serwisowej na niżej podany adres e-mailowy. W ten sposób możemy przesłać Państwu tylko brakujące części. W przypadku innych reklamacji dotyczących mebla, prosimy zgłosić się do salonu meblowego, w którym został dokonany zakup.

HR Servis za okove
U slučaju da nedostaje neki od dijelova molimo vas da na dolje navedenu mail adresu pošaljete ovaj servisni obrazac. Na ovaj način mogu se dostaviti samo okovi. U slučaju da imate dodatne prigovore vezane uz komad namještaja molimo vas da se obratite izravno trgovini namještaja gdje je isti kupljen.

HU Direktszolgáltatunk vasalokat eseten
Ha hiányzik egy vasalat, ezt a kártyát közvetlenül elküldheti az alább található címre. Azonban csakis vasalokat tudunk így küldeni. Amennyiben másfajta reklamáció áll fenn bútordarabját illetően, forduljon közvetlenül a bútortházhoz.

SK Naš priamy servis pre časti kovania
Ak by Vám chýbala nejaká časť kovania, môžete poslať túto servisnú kartu poslať e-mailom na nižšie uvedenú adresu. Diely kovania vieme poslať iba týmto spôsobom. Ak by ste mali inú reklamáciu ohľadom Vášho nábytku, obráťte sa priamo na Vašu predajňu nábytku.

SLO Naše direktno uslužne storitve za okovje
Če vam manjka kakšno okovje, lahko to servisno kartico pošljete po e-pošti direktno na spodnji naslov. Po tej poti vam lahko pošljemo samo okovje. Če želite reklamirati kakšen drug del pohištva, se obrnite neposredno na vašo trgovino pohištva.

RO Service-ul nostru direct pentru feronerie
În cazul în care vă lipsește o piesă de feronerie puteți să trimiteti direct acest card de service prin e-mail la adresa de mai jos. Noi nu putem expedia piese de feronerie decât pe această cale. Dacă aveți o altă reclamație referitoare la piesa de mobilier, atunci vă rugăm să vă adresați direct la magazinul dvs. de mobilă.

RUS Наш прямой сервис для поставок фурнитуры
Если окажется, что Вам не хватает того или иного элемента фурнитуры, Вы можете отправить сервисную карту по факсу непосредственно на нижеприведенный адрес электронной почты. Однако, таким образом мы можем пересылать лишь фурнитуру. Если же у Вас возникнут иные претензии относительно приобретенной мебели, пожалуйста, обращайтесь непосредственно в организацию, осуществившую продажу.

S Vår direktservice för beslagsdelar
Om du saknar en beslagsdel kan du skicka detta servicekort direkt till e-postadressen som anges nedan. Tänk på att detta är den enda möjligheten att skicka beslagsdelar till dig. Om du vill reklamera din möbel av en annan anledning måste du kontakta ditt möbelhus direkt.

ES Nuestro servicio directo para accesorios
Si le falta algún accesorio, puede enviar esta tarjeta de servicio directamente a la siguiente dirección. No obstante, por este método solo podemos enviar accesorios. Si tiene alguna otra objeción sobre su mueble, consulte directamente con su mueblería.

TR Donatılar için doğrudan servisimiz
Bir donatınız eksikse bu servis kartını doğrudan aşağıda bulunan adrese doğrudan mail yazabilirsiniz. Sadece bu yolla donatılar gönderilebilir. Mobilyanızda başka şikayetleriniz varsa lütfen doğrudan mobilya satıcınıza danışın.

1	802	400	16	x1	1/2
2	802	400	16	x1	1/2
3	1868	380	16	x1	2/2
4	1868	380	16	x1	2/2
5	1868	360	16	x1	2/2
6	445	360	16	x1	1/2
7	445	360	16	x1	1/2
8	307	345	16	x4	1/2
9	444	345	16	x2	1/2
10	702	80	16	x1	1/2
11	668	80	16	x1	1/2
12	333	80	16	x1	1/2
13	333	80	16	x1	1/2
14	1882	322	3	x1	2/2

15	696	459	3	x1	1/2
16	452	459	3	x1	1/2
17	730	459	3	x1	1/2
18	1878	319	16	x1	2/2
19	702	475	16	x2	1/2
20	475	32	16	x1	1/2
21	468	32	16	x1	1/2
22	444	340	6	x1	2/2

Grund der Beanstandung / Cause for complaint:

Möbelhaus / Furniture store:

Kunde / Customer:

Telefon / Telephone:

PLZ / Postcode:

Ort / City:

Str. +Nr. / Street address

@E-Mail:

LKZ_80236

Modellname / Model name / Nom du modèle / Modellnamn
Nome modello / Název modelu / Modelnaam / Ime modela
Número Modelo / Modell neve / Название модели /
Názov modelu / Ime modela / Denumire model /
Наименование на модела / Nazwa modelu

Synnax











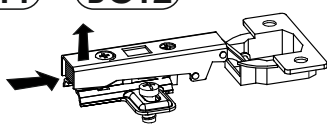

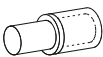
Modellnummer / Number / Numéro du modèle
Numero / Номер на модела / modello
Číslo modelu / Modell száma / Ěíslo modelu
Številka modela / Număr model / Broj modela
Modelnummer / Numer modelu

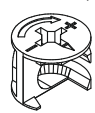
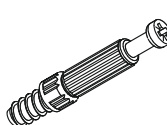
2134-131-84

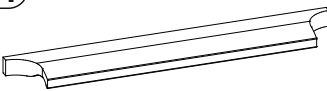
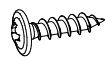
Type / Tipo / Tipus / Тип / Тип / Tip

131

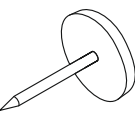
B1 Colli 1/2

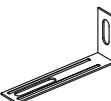
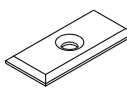
A1 8 x 35 x30 	BC11 + BC12 x8 	C2 5x13 x16 
D2 x28 	E0 x18 	E1 15 x 12,5 x28 
F1 x28 	G1 7 x 50 x6 	H1 L-180 x3 
I2 4 x 16 x2 	I5 3,5 x 27 x6 	M x1 
N1 3 x 16 x20 	O2 x6 	P0 x4 
P15 x2 	Q9 x2 	R1 x18 

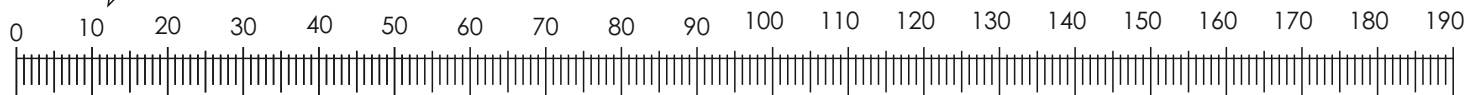
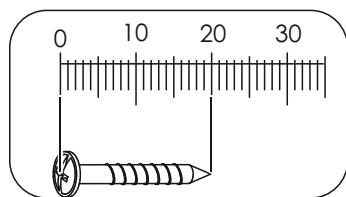

MM

LKZ 80236

Modellname / Model name / Nom du modèle / Modellnamn
Nome modello / Název modelu / Modelnaam / Ime modela
Numéro Modello / Modell neve / Название модели /
Názov modelu / Ime modela / Denumire model /
Наименование на модела / Nazwa modelu

SynnaX

Modellnummer / Number / Numéro du modèle
Numero / Номер на модела / modello
Číslo modelu / Modell száma / Ěíslo modelu
Številka modela / Număr model / Broj modela
Modellnummer / Numer modelu

2134-131-84

Type / Tipo / Típus / Тип / Тип / Tip

131

B1 Colli 1/2

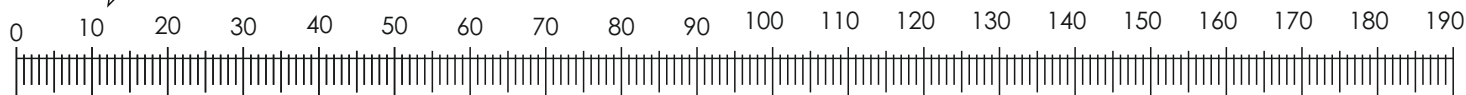
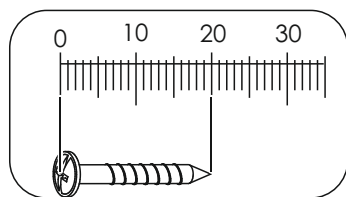
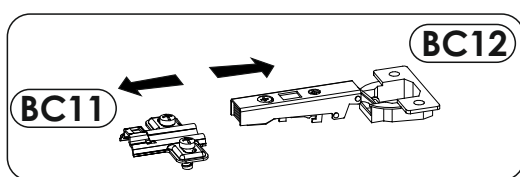
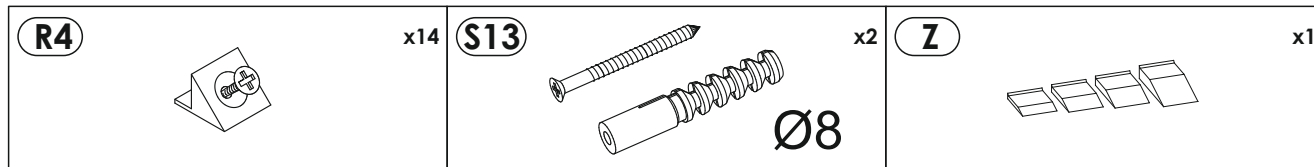

Değerli müşterimiz, evde kullanım için tasarlanan iç mekan programımızdan bir mobilyaya satın aldığınız için teşekkür ederiz. Lütfen teslimat kapsamının eksiksiz olup olmadığını kontrol edin ve montajdan önce aşağıdaki önemli bilgileri dikkatlice okuyun ve daha sonra kullanıcı şahıslar tarafından da kullanılmak üzere saklayın.

Mobilyalarımız amaçlandığı şekilde kullanılmalıdır. Amacı dışında kullanım, maddi hasarlara veya bazı durumlarda kişisel yaralanmalara neden olabilir. Mobilyalar çocuk oyuncakları değildir. Üretici veya satıcı, amacı dışında veya yanlış kullanımdan kaynaklanan hasarlar için hiçbir sorumluluk kabul etmez.

D İ K K A T: Çocuklar veya zihinsel engelli kişiler, yaralanma ve/veya bozulma riski bulunduğundan, mobilya parçalarından, sırtı içi nesnelere, küçük parçalardan ve ambalaj malzemelerinden daima uzak tutulmalıdır.

M O N T A J: Montaj sırasında lütfen işletim, kullanım, kurulum veya montaj talimatlarınıza uyun ve uyan ve güvenlik talimatlarına özellikle dikkat edin. Talimatlara uyulmaması, kişisel yaralanmaya veya mobilya hasarına/güvenlik riskine neden olabilir.

Montaj / kurulum konusunda zorluk yaşıyorsanız, lütfen servis ekibimize iletişime geçin. Ekibimize tavsiyeyle ve destekleriyle size yardımcı olacaktır. Montaj sadece uzman kişiler tarafından yapılmalıdır.

Ürün/ürün parçalarında değişiklikler, üreticiden/satıcıdan gelmeyen parçalarla/sarf malzemeleriyle değiştirilmesi veya kullanılması durumunda meydana gelebilecek hasarlar için sorumluluk kabul edilmez.

Ürünlere dübel ve vida gibi duvara sabitleme araçları eklenmişse, bunlar sadece sağlam ve tek tip malzemelerden yapılmış duvarlarda kullanılmak üzere tasarlanmıştır. Bir bağlantı sadece bağlantı elemanı ve duvar arasındaki bağlantı kadar iyidir. Lütfen mobilyayı sabitlemeden önce duvarınızın hem ayakta hem de asılı mobilya için uygunluğunu kontrol edin ve sadece uygun bağlantı elemanları kullanın. Olası bir delme işleminden önce delme alanında tesisat olmadığının emin olun. Sonuçta, montaj yapan kişi duvara sabitlemekten sorumludur.

Bu aynı zamanda elektrikli parçaların ve diğer yapısal aksesuarların montajı için de geçerlidir. Elektrikli parçaların ve diğer inşaatla ilgili aksesuarların montajı/kurulumu sadece yetkili uzman personel tarafından yapılabilir. Tüm elektrik ve yapısal kurulumlar, eyaletinizdeki geçerli standartlara ve güvenlik yönetmeliklerine uygun olarak yapılmalıdır.

Işık kaynakları için lütfen sadece izin verilen aydınlatma güçlerini kullanın. Maksimum Watt değerine uyulmaması durumunda aşırı ısınma nedeniyle yangın riski söz konusudur. Yangın tehlikesi nedeniyle aydınlatmaların üstünü kapatmak yasaktır.

Mobilyaların düzgün fonksiyonu sadece düz ve yatay konumda garanti edilir. Kapılar önceden ayarlanmıştır, ancak yerel koşullar nedeniyle yeniden hizalanması/ayarlanması gerekebilir. Lütfen maksimum yük ile ilgili ağırlık bilgilerine uyun. Mobilyaların üzerine çıkılması yasaktır. Yanlış kullanım mobilyaların devrilmesine neden olabilir. Bunu önlemek için mobilyalar her zaman devrilmeye karşı emniyete alınmalıdır. Aşırı yük/aşırı zorlama durumunda (özellikle oyun oynayan çocuklar, insanlar, malzeme veya diğer uygunsuz etkiler nedeniyle) kırılma ve yaralanma riski söz konusudur. Kalıcı sağlamlığı güvenceye almak için tüm duvalar ve yük taşıyan bağlantı noktaları 5-6 hafta sonra tekrar sıklımalıdır.

B A K I M:
-Mobilya bakımına ilgili notlar-
Ürünümüzün keyfini otaladığınızca uzun süre çıkarılabilen için lütfen uygun mobilya bakımıyla ilgili talimatlarımızı dikkate alın.

Temizlik sırasında temiz, kuru ve yumuşak pamuklu bir bez kullanın. Mobilyanızın kapsamlı bir temizliğe ihtiyacı varsa, bezi biraz su veya mobilya temizleyicisiyle nemlendirilebilir ve ardından temizlenen eşyaları kurutabilirsiniz. Metal ve cam parçaları, üzerindeki bakım talimatlarına göre piyasada bulunan metal ve cam temizleyicilerle en iyi şekilde temizleyebilirsiniz. Temizlik maddeleri, mobilya temizliği için uygun olduklarının açık bir göstergesini taşımaktadır.

Hiçbir koşulda buharlı temizleyiciler, kostik, aşındırıcı veya etkilere aşırı olmadığınız diğer maddeleri kullanmamalısınız.

D İ K K A T: Çok parlak yüzeyler teslimat sırasında koruyucu bir folyoyla korunur. Bunu tamamen monte edilene ve tozu temizlenene kadar mobilya üzerinde bırakın. Koruyucu folyonun çıkarıldığı çok parlak elemanlar ancak 72 saat sonra temizlenebilir ve kullanılabilir (ortam havasında son katlaşma süresi). Yüzeylere keskin nesnelere zarar vermeyin ve asla güçlü güneş ışığına maruz bırakmayın.

T A S F İ Y E
-Tasfiyeyle ilgili notlar-
Çevre için lütfen türüne göre ayrılmış ambalaj atıklarını doğaya değil, bunlar için sağlanan atık/geri dönüşüm kutularında tasfiye edin.

Hasarlı veya kullanılmaz mobilyalar, her bir parçanın geri dönüştürülmesi için özel geri kazanım tesislerine gönderilebilir.

Artık kullanılmayan ancak hala işlevsel olan mobilyalarınızı hemen tasfiye edilmesi gerekmektedir. Bunları örneğin hayır kurumlarına bağışlayın.

Yeni mobilyalarınızı güle güle kullanın.

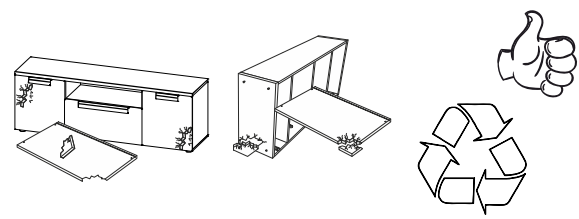
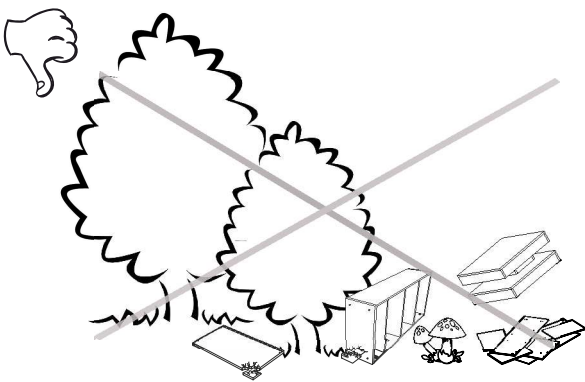
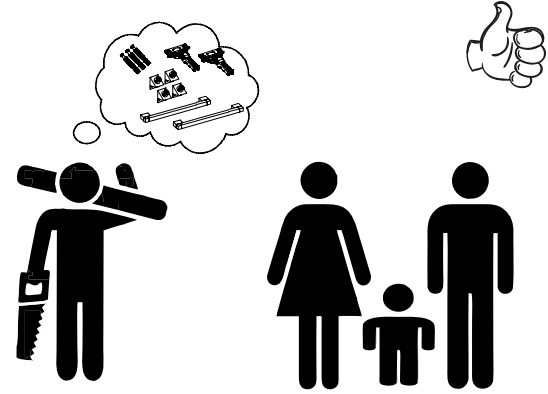
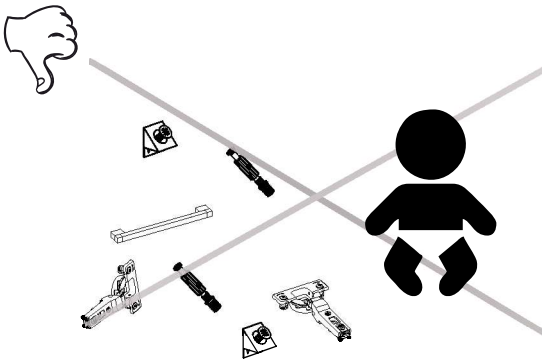
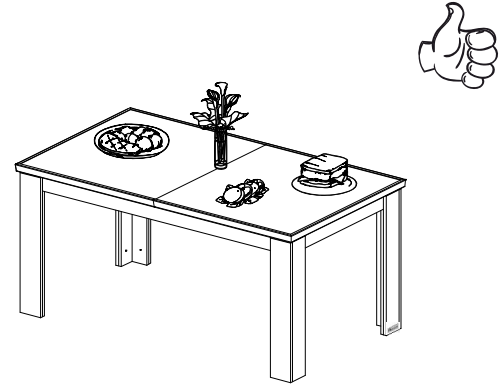
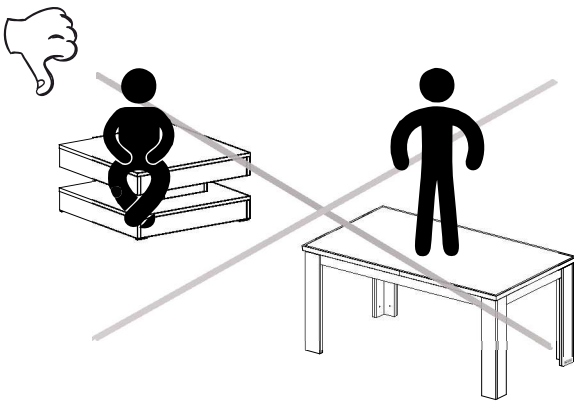
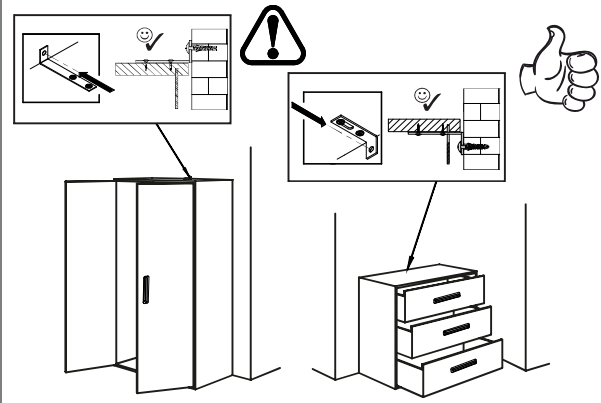
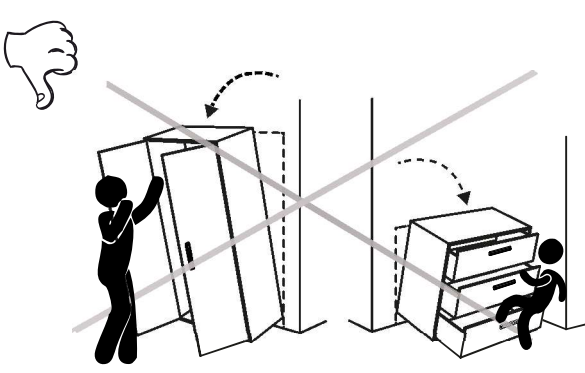

1

A1 8 x 35



x4

BC11

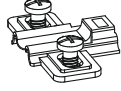

x4

E1 15 x 12,5

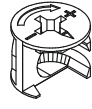

x2

F1

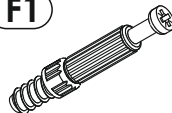

x4

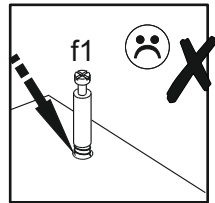
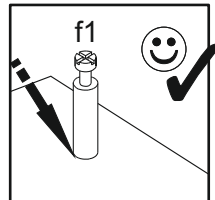
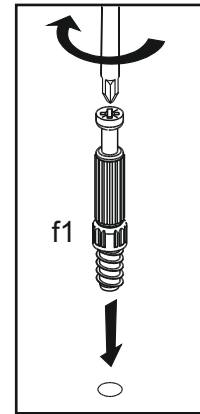
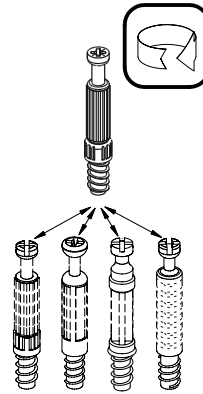
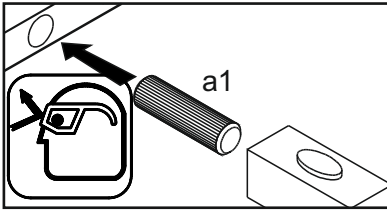
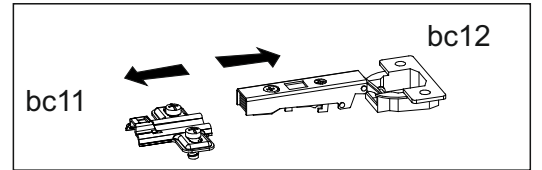
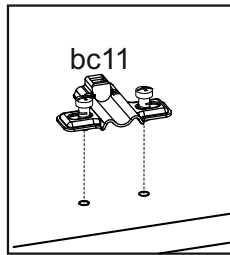
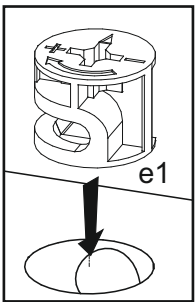
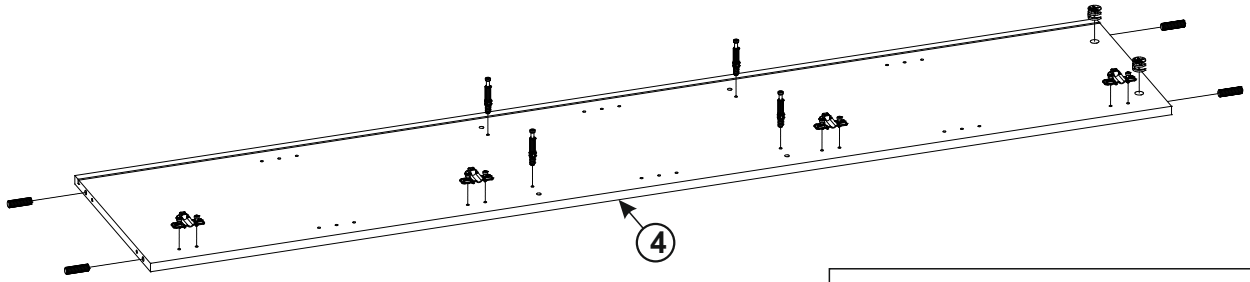
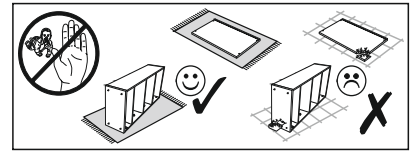

2

A1 8 x 35



x6

E1 15 x 12,5



x6

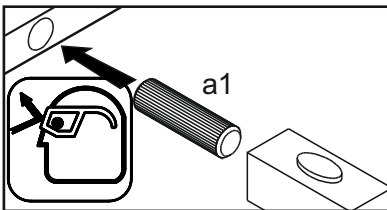
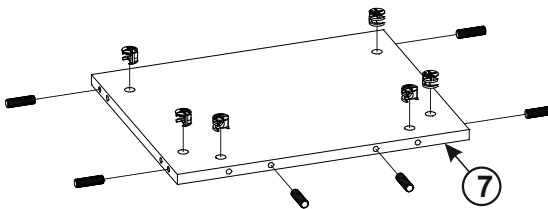
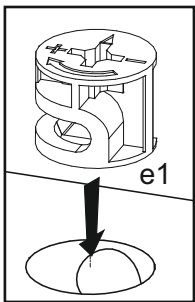
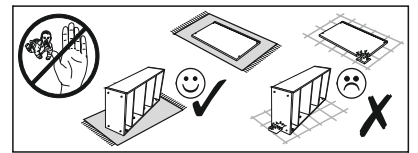

3

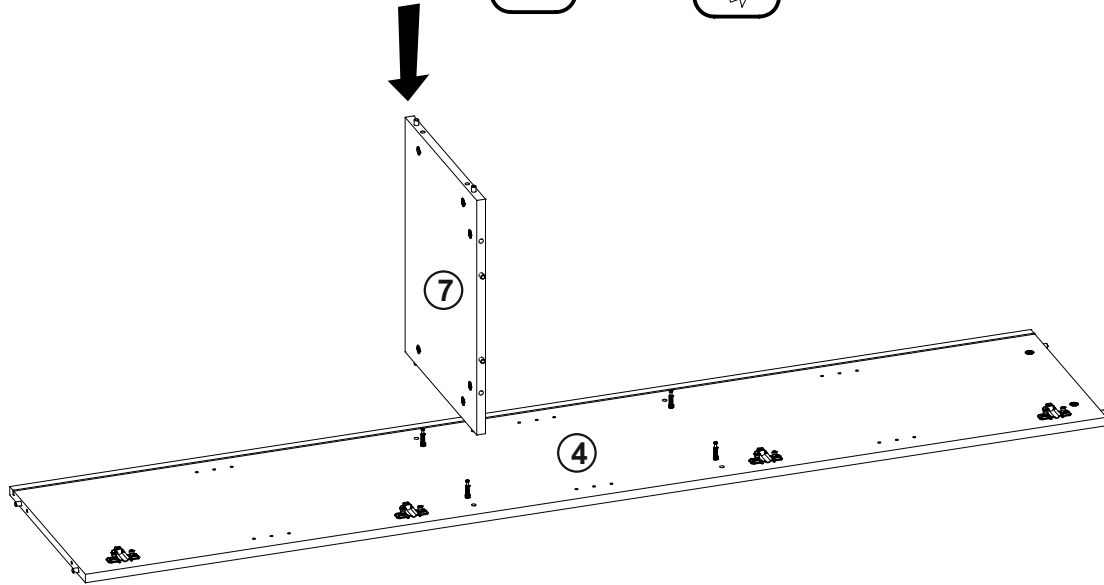
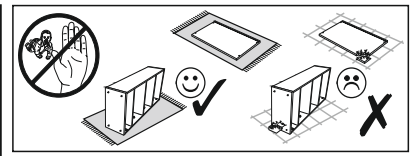
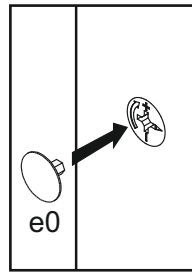
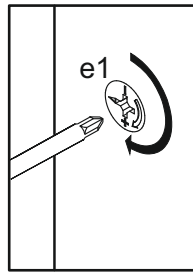
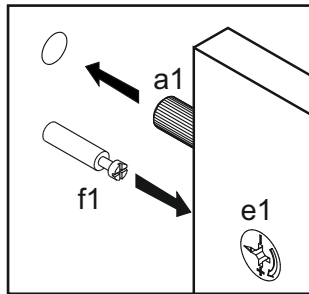
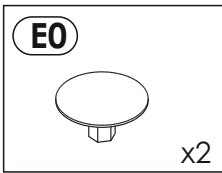

4

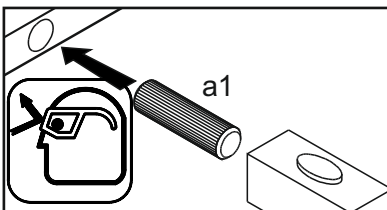
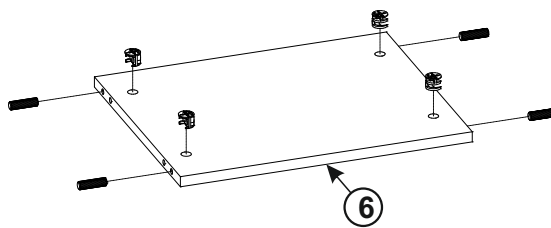
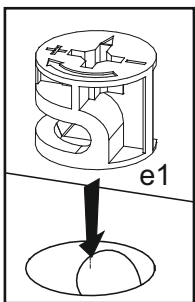
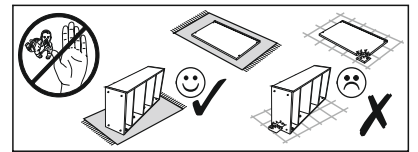
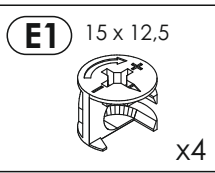
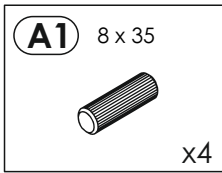

5

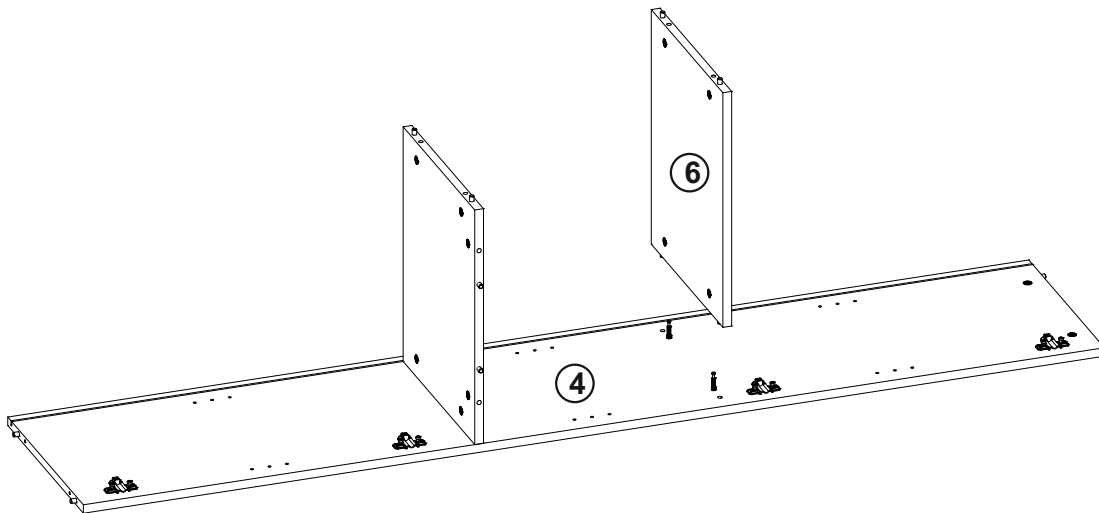
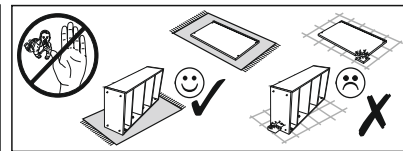
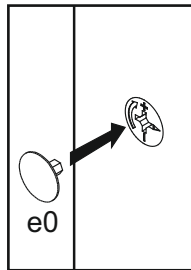
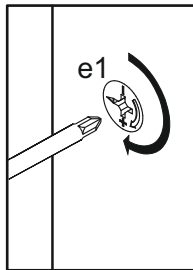
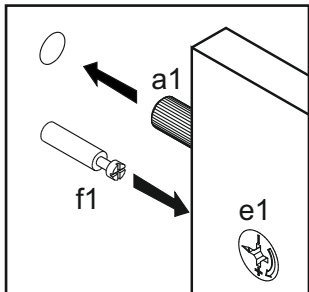
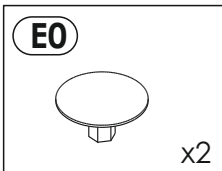

6

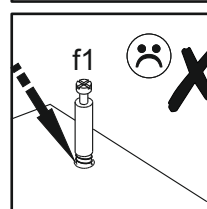
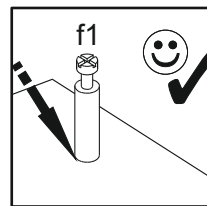
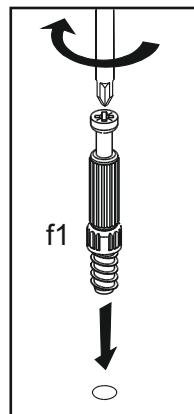
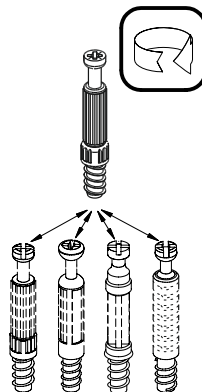
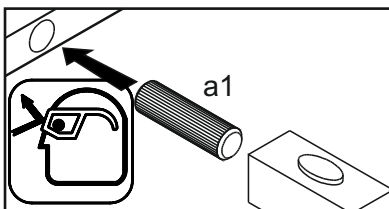
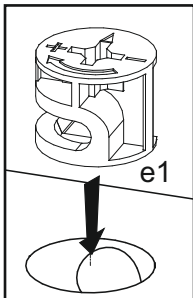
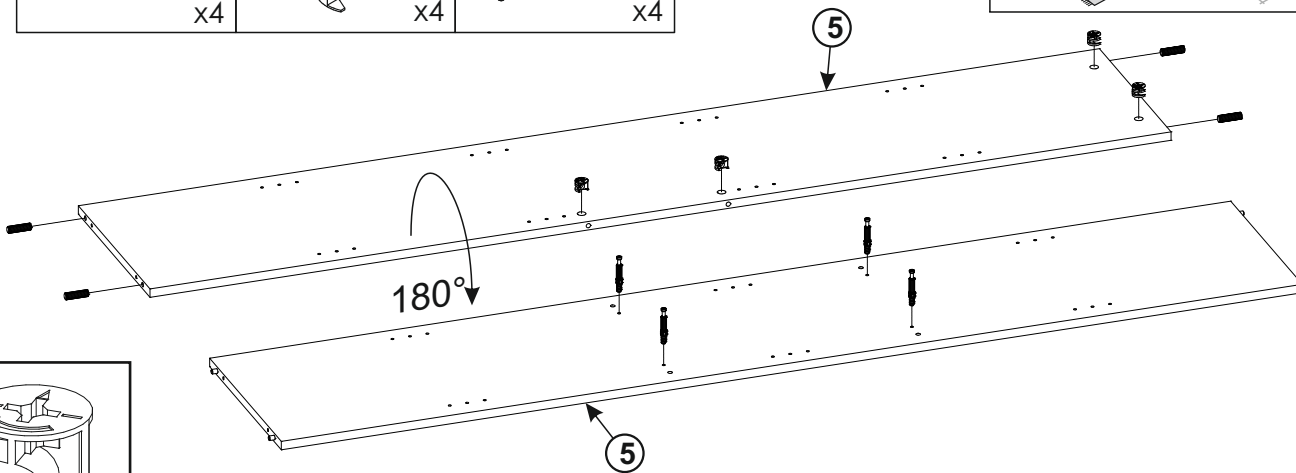
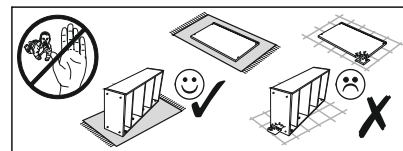
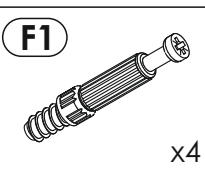
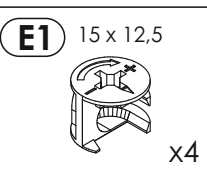
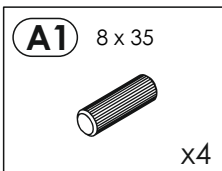

7

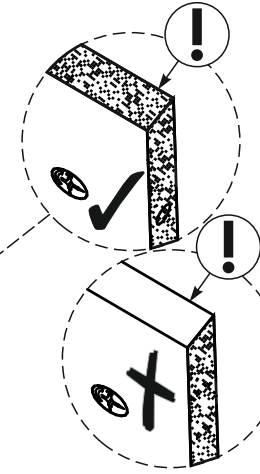
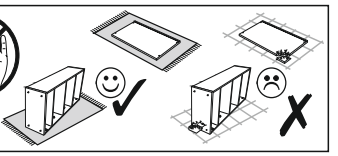
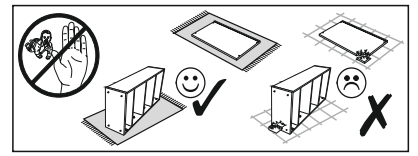
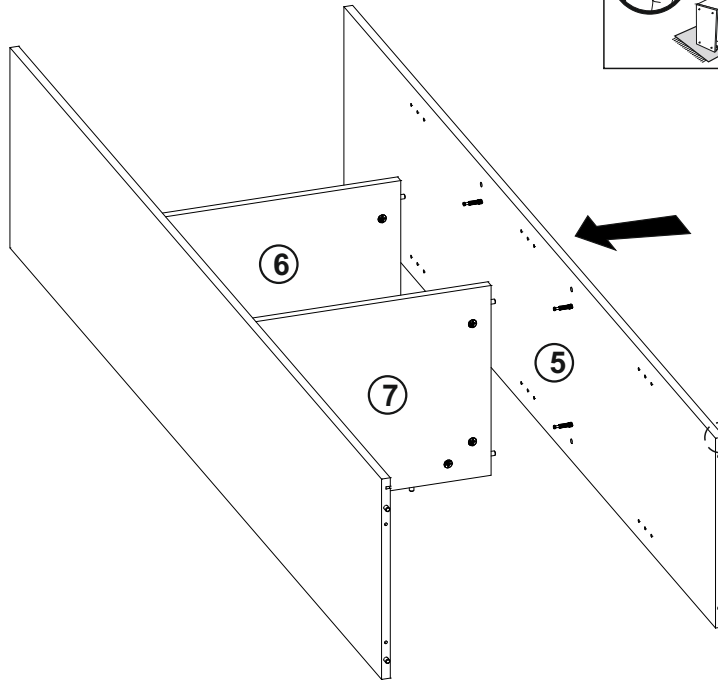
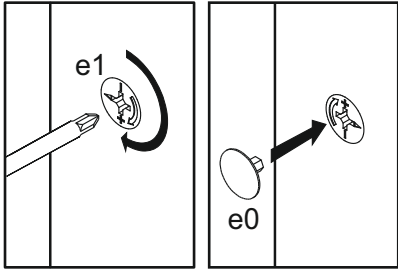
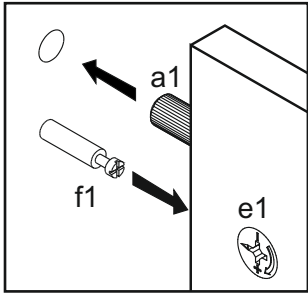
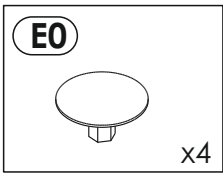

8

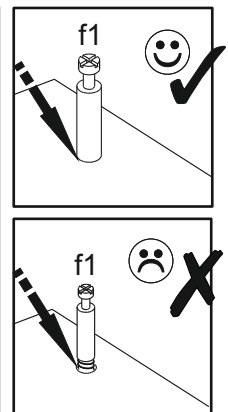
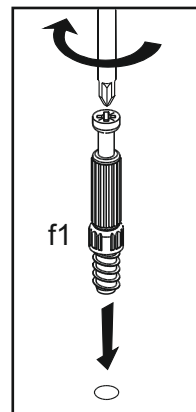
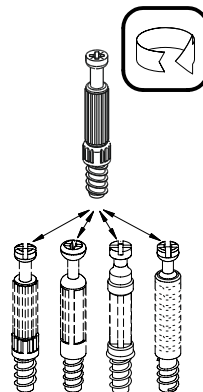
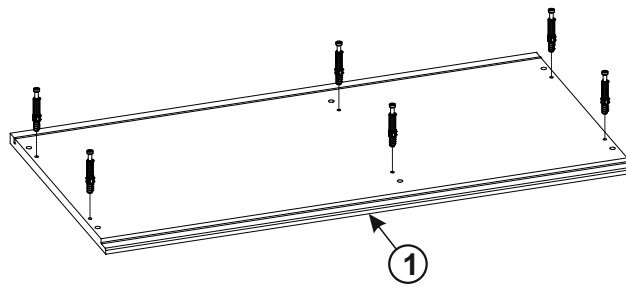
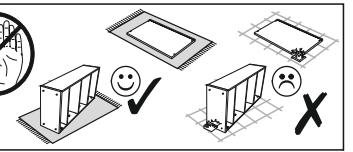
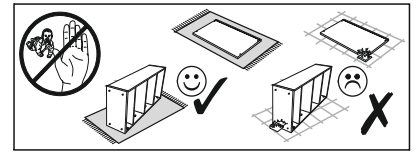
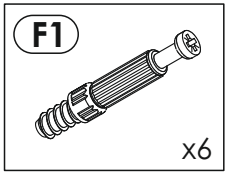

9

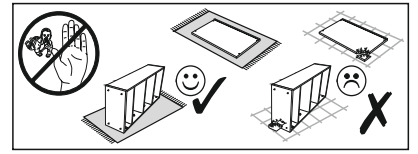
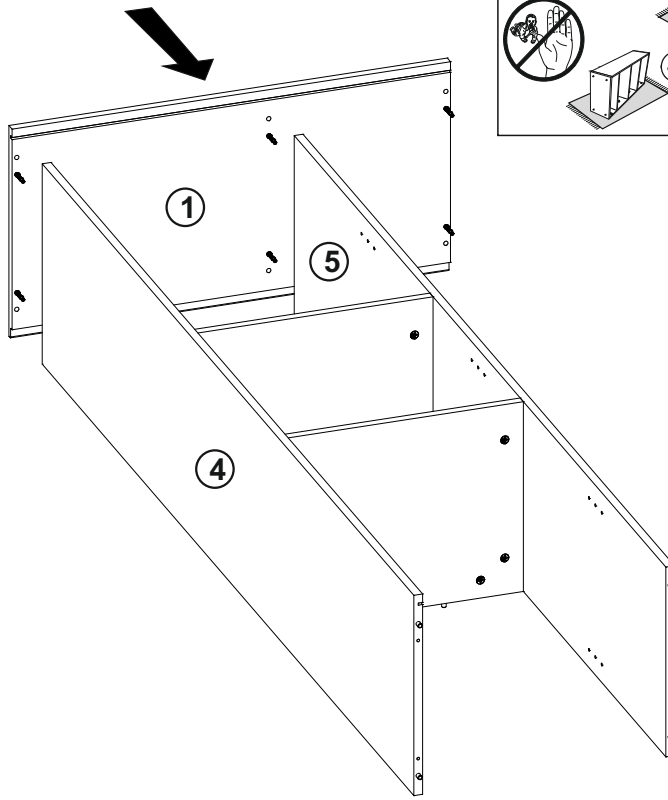
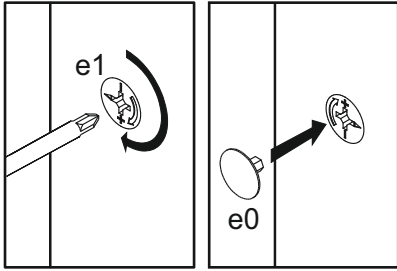
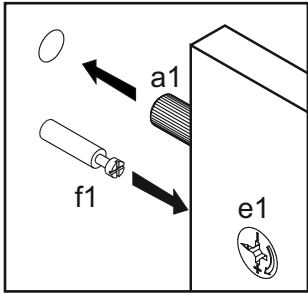
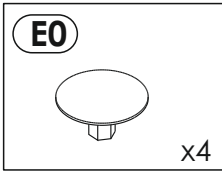

10

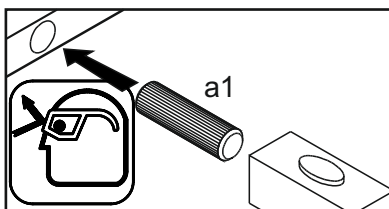
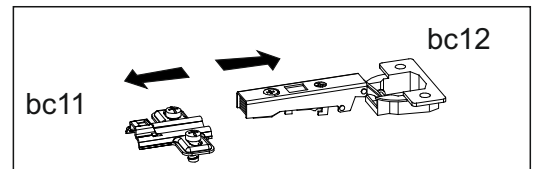
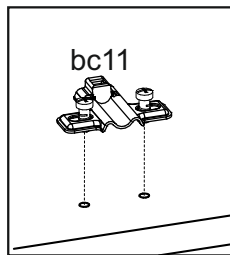
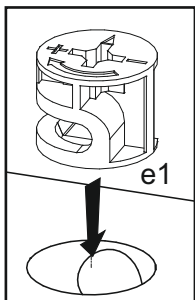
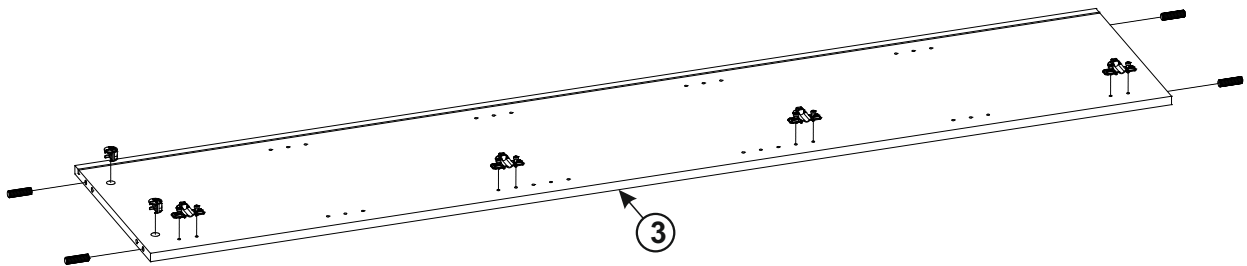
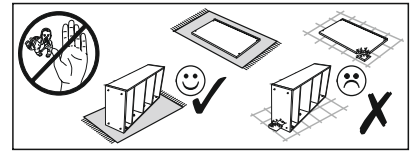
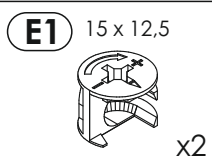
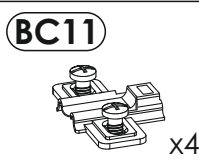
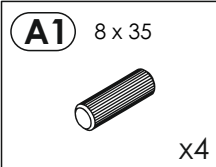

11

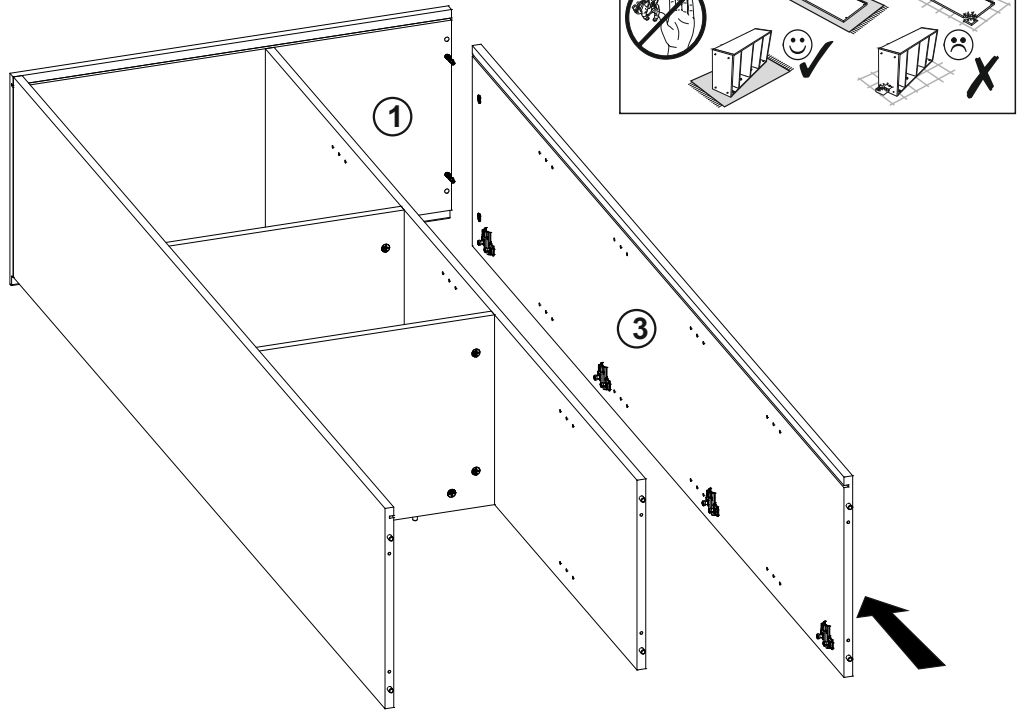
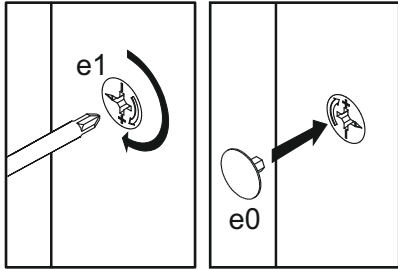
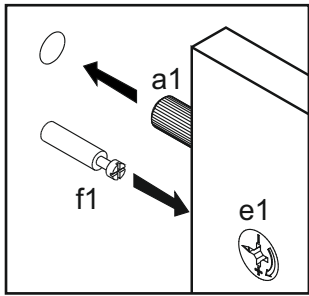
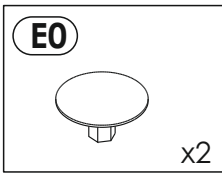

12

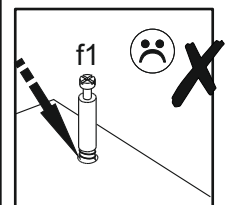
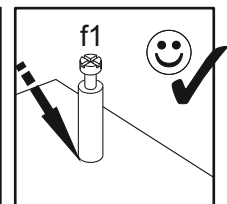
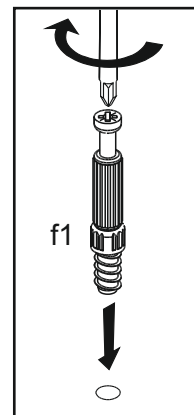
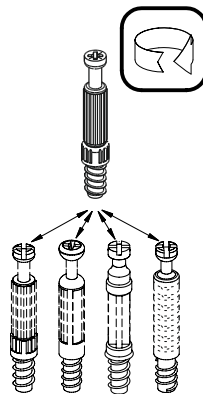
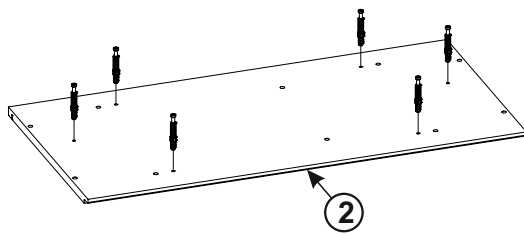
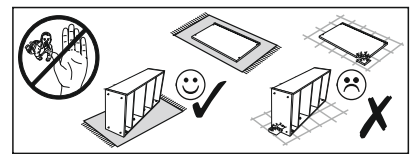
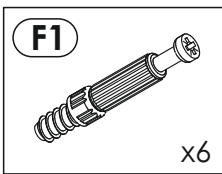

13

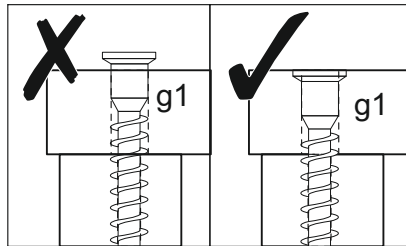
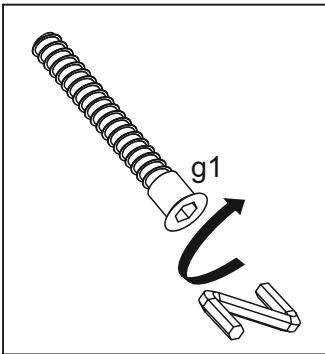
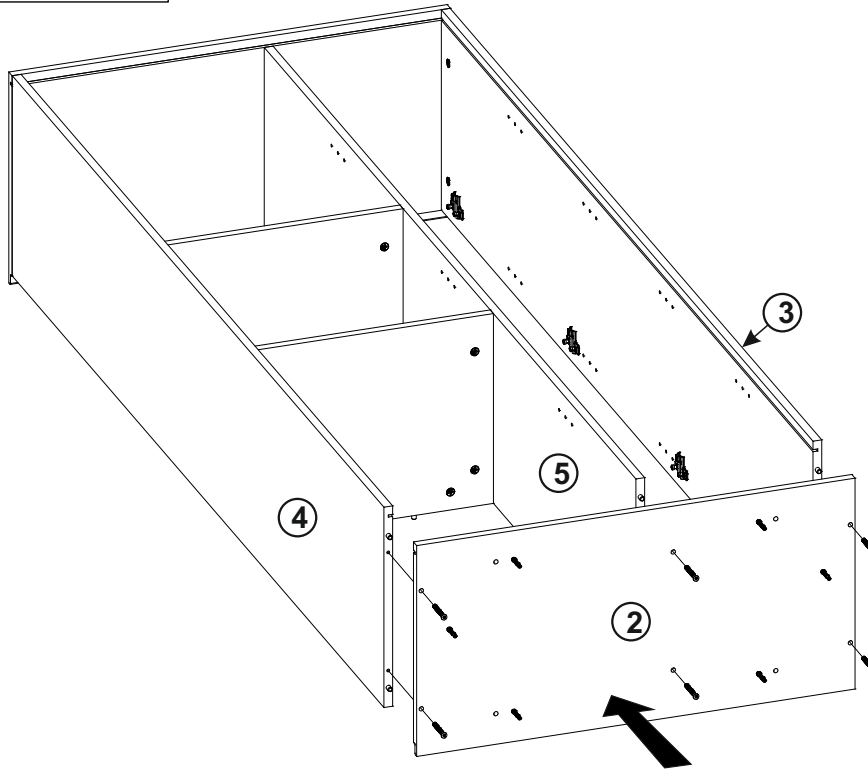
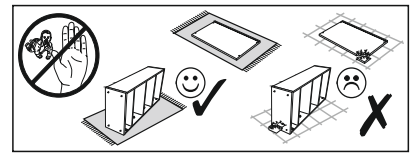
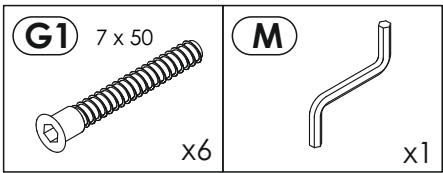

14

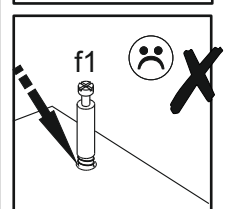
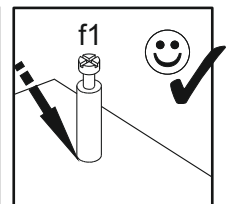
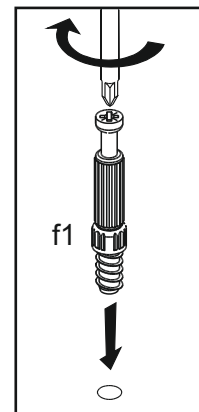
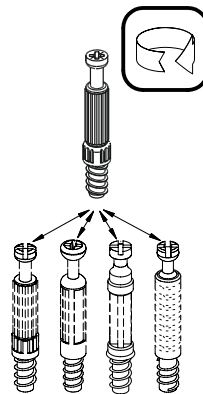
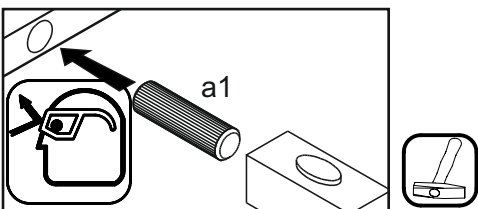
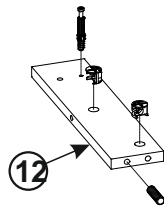
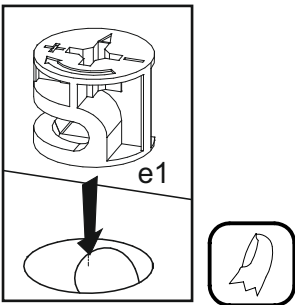
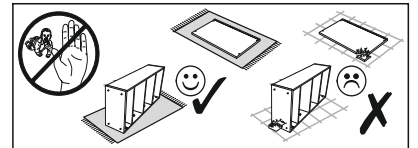
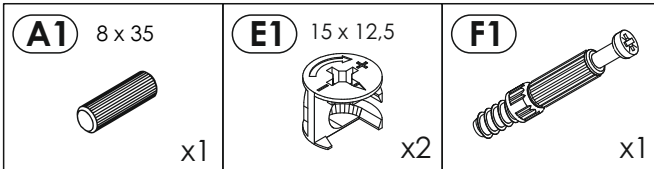

15

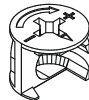
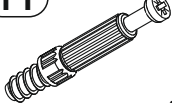
<p>A1 8 x 35</p>  <p>x1</p>	<p>E1 15 x 12,5</p>  <p>x2</p>	<p>F1</p>  <p>x1</p>
---	--	--

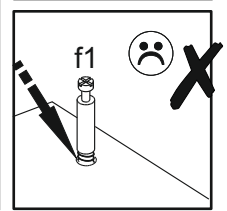
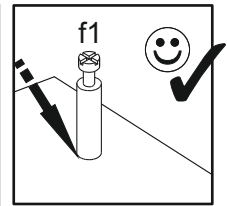
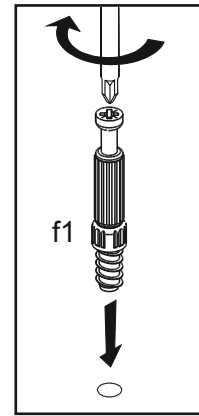
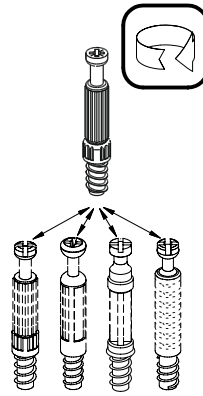
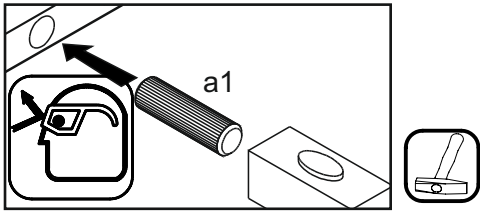
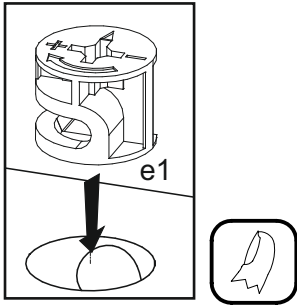
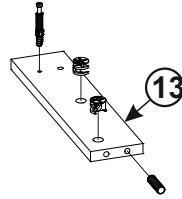
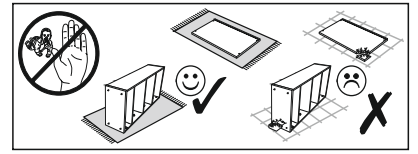

16

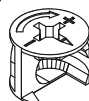
<p>A1 8 x 35</p>  <p>x4</p>	<p>E1 15 x 12,5</p>  <p>x4</p>
---	--

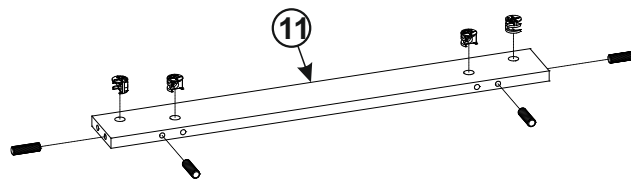
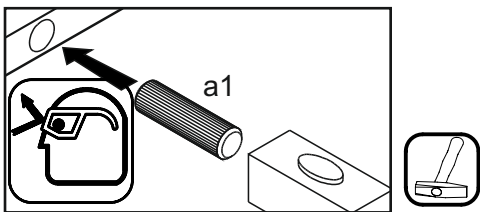
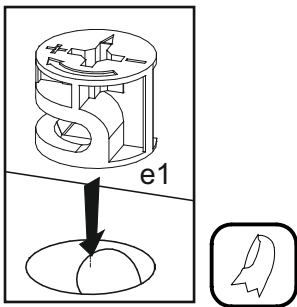
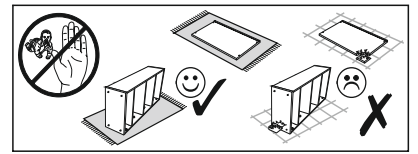

17

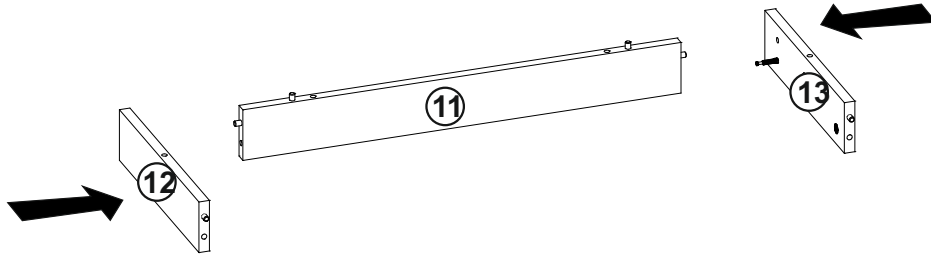
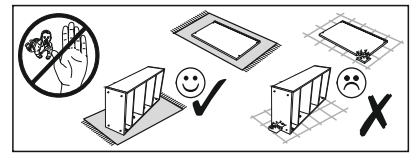
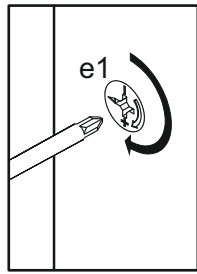
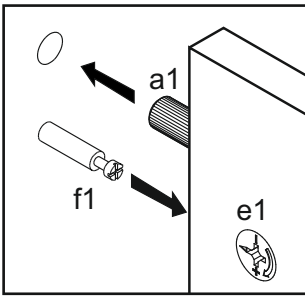

18

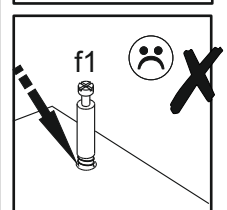
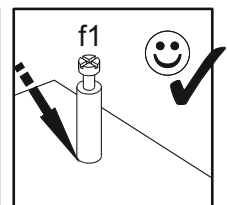
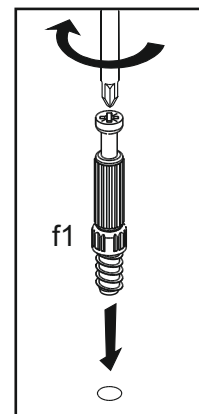
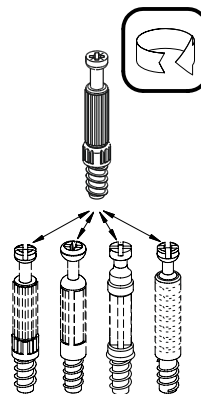
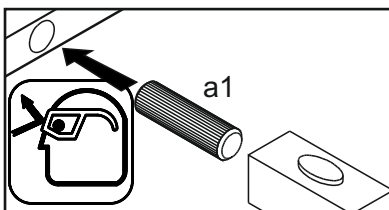
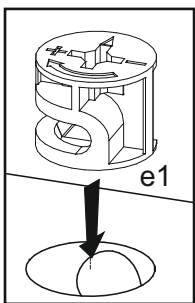
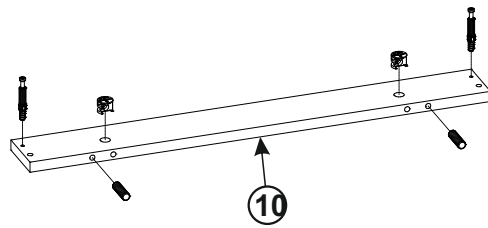
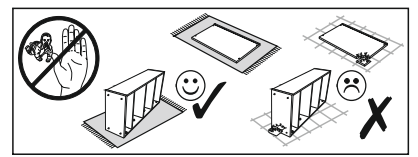
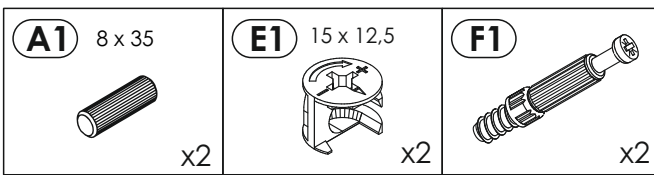

19

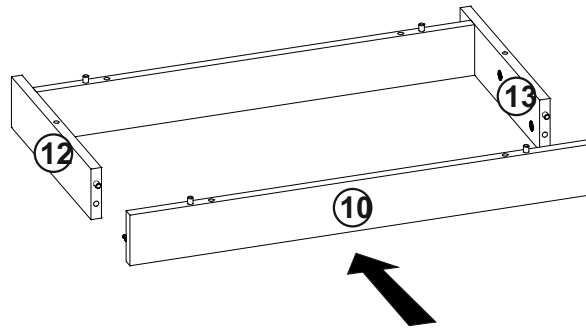
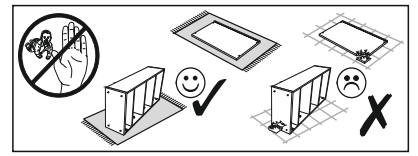
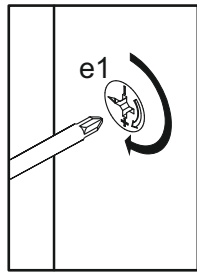
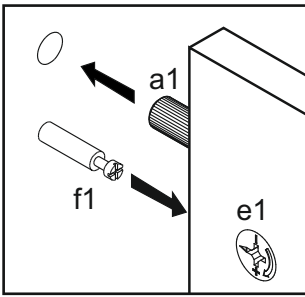

20

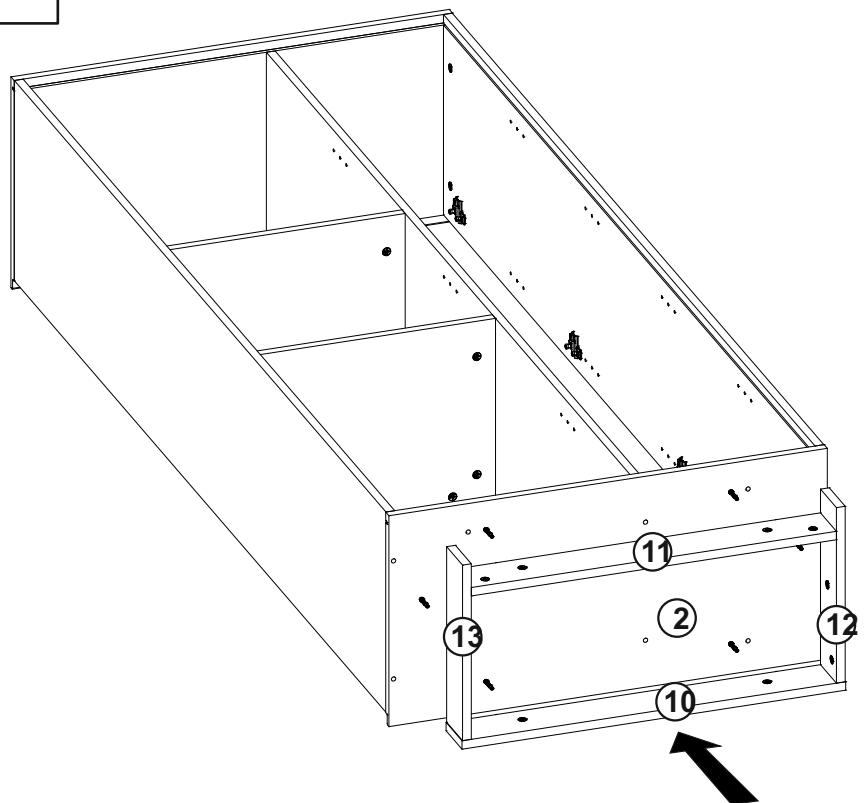
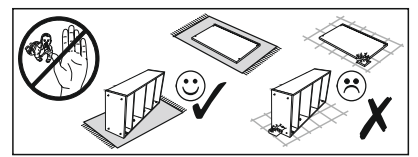
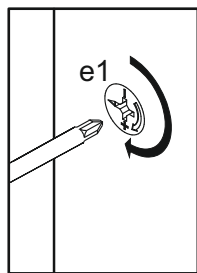
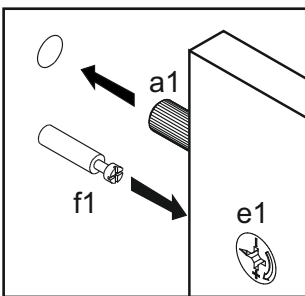

21

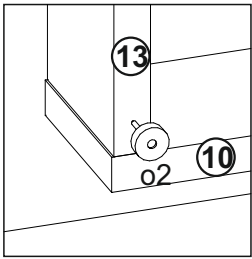
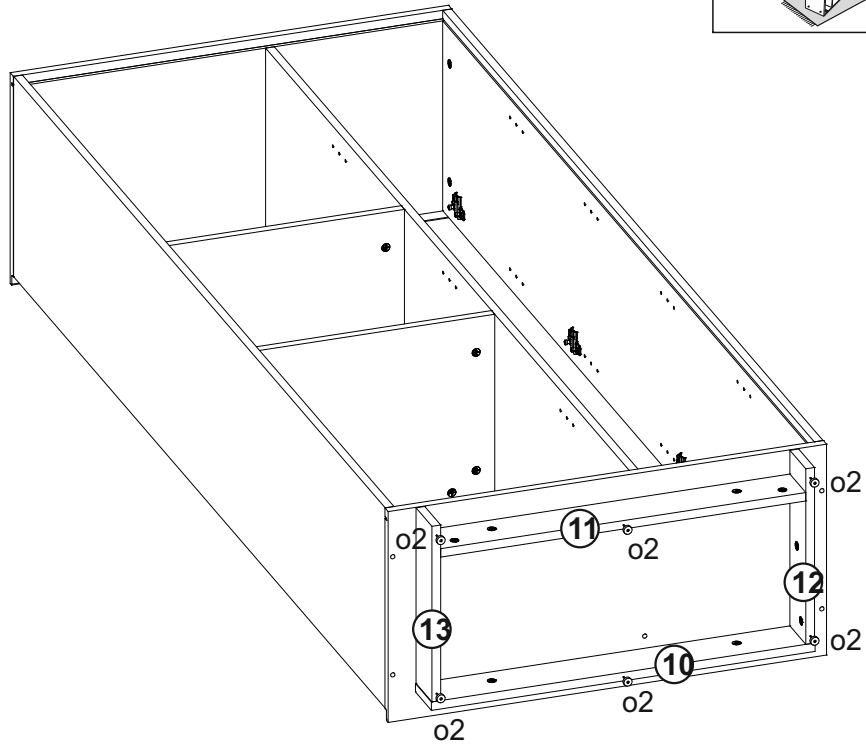
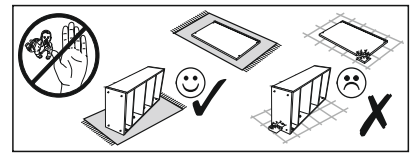
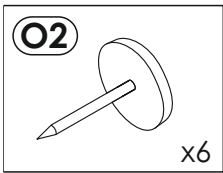

22

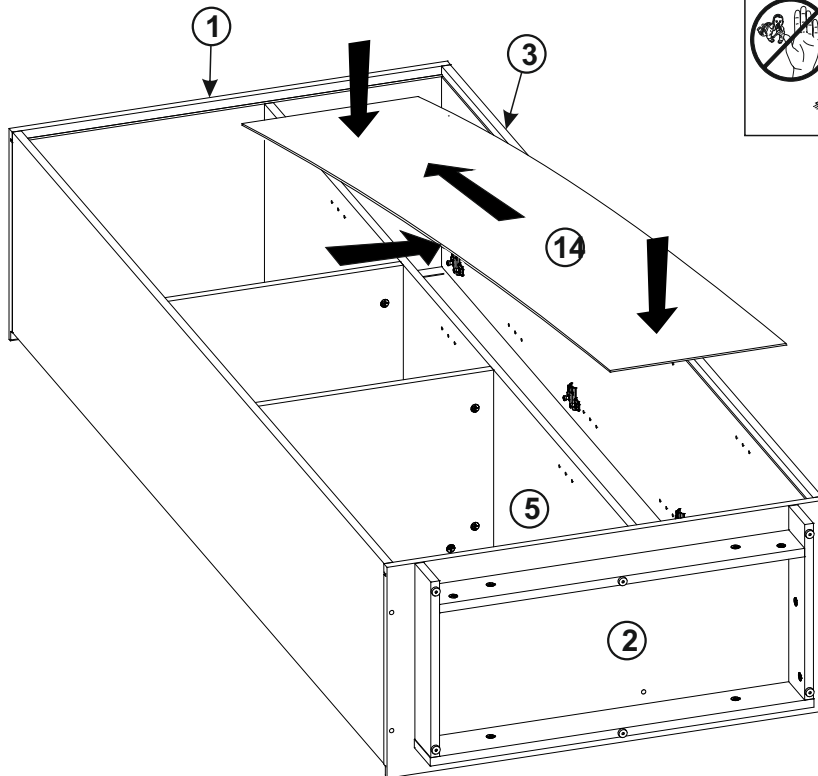
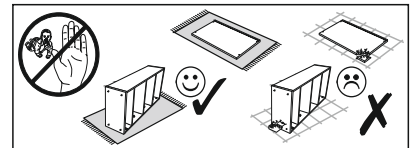

23

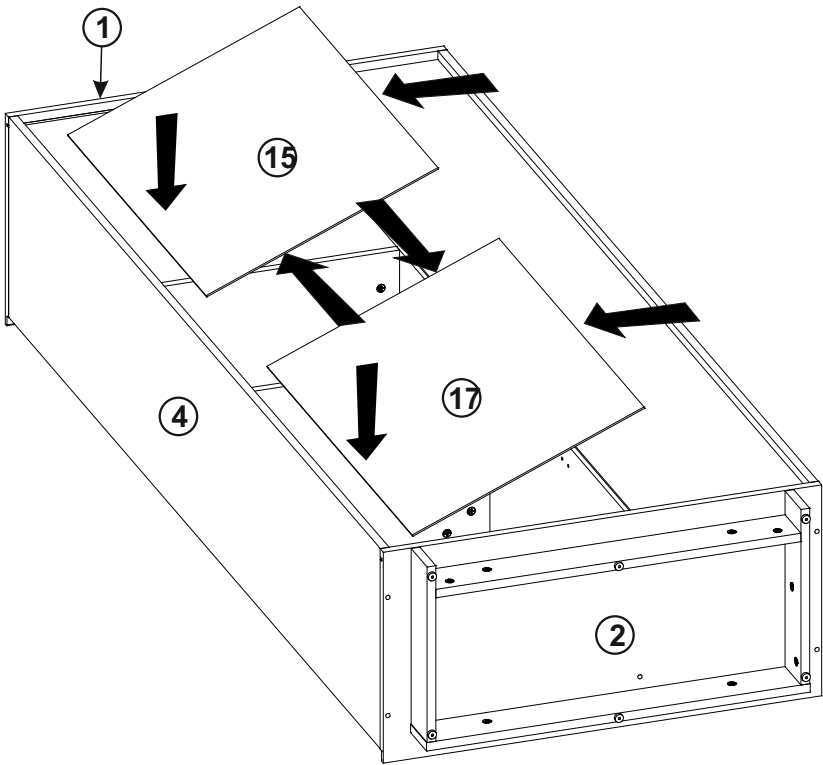
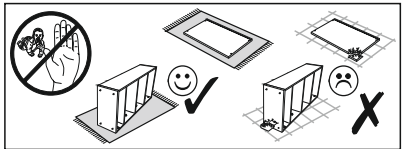

24

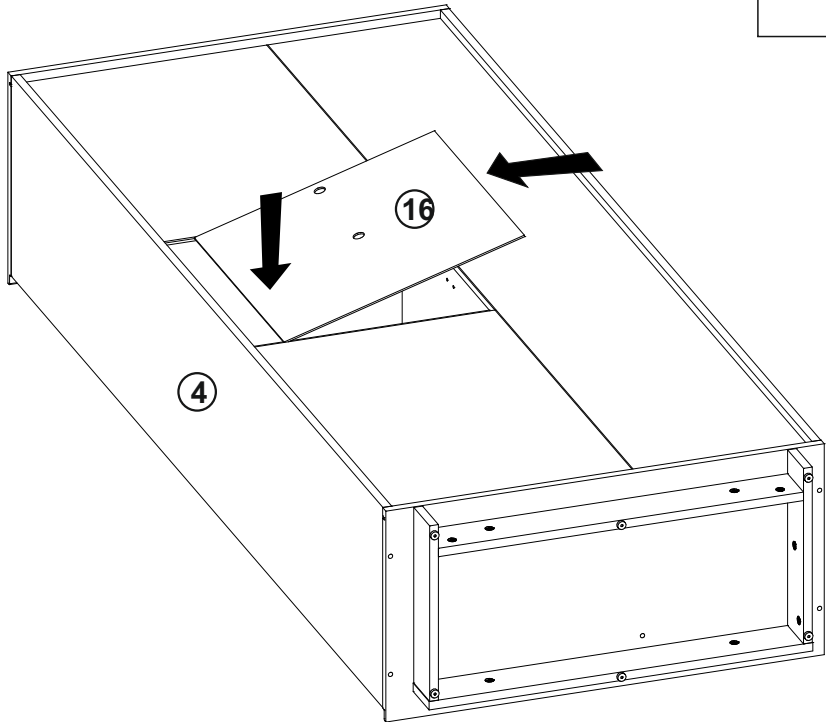
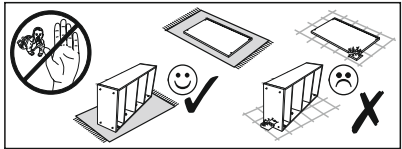

25



A=B

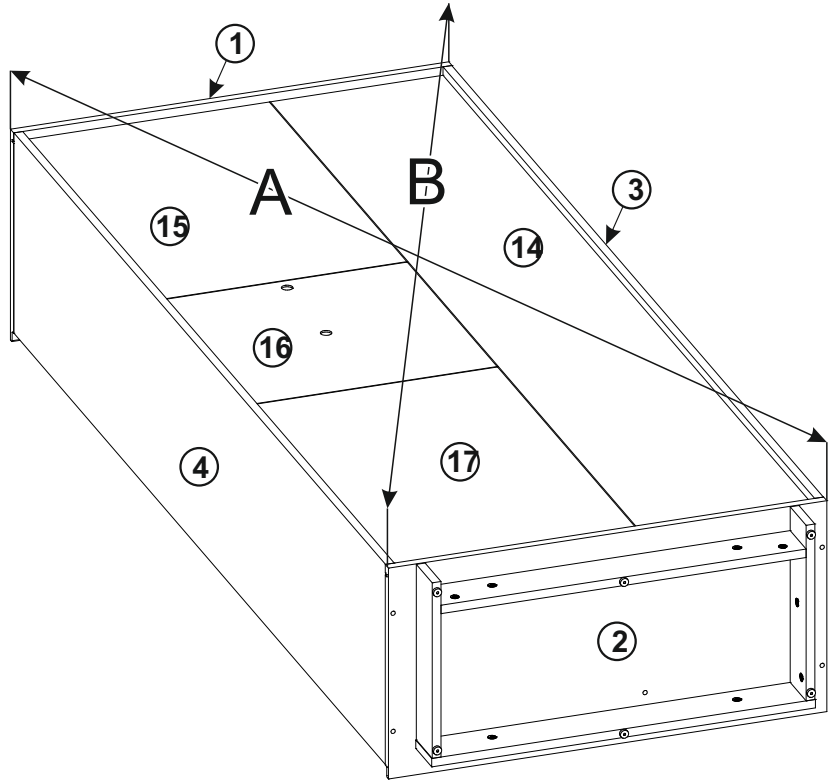
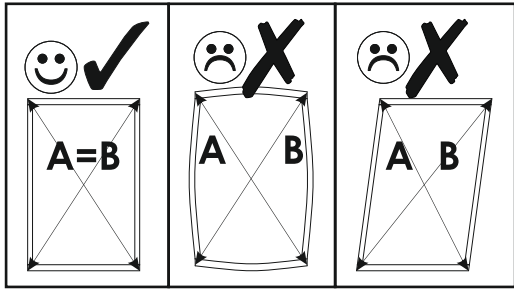

26

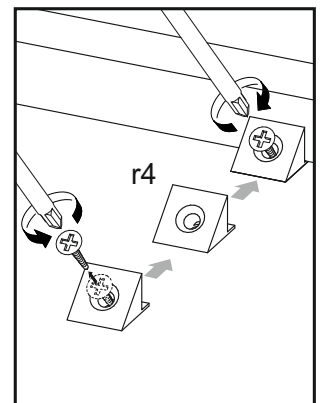
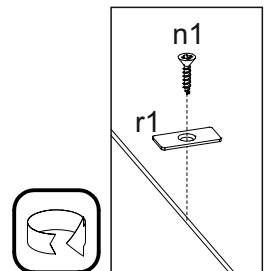
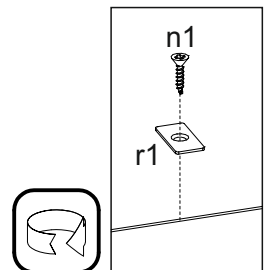
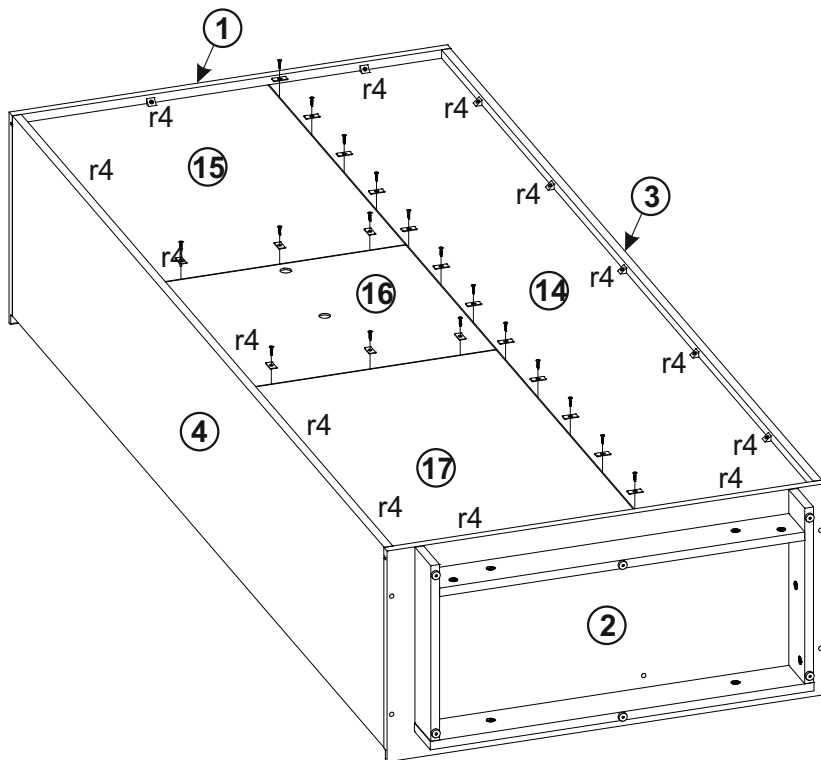
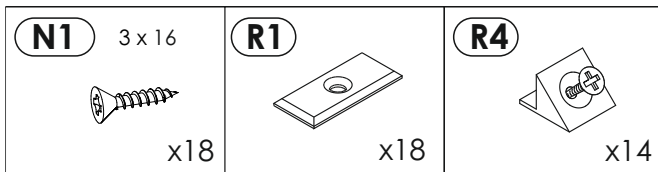

27

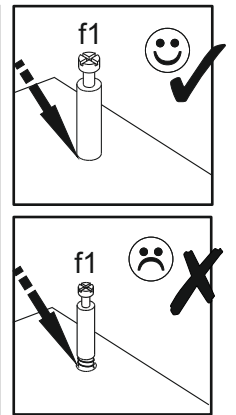
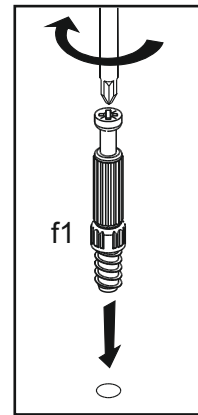
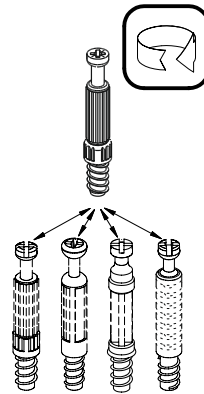
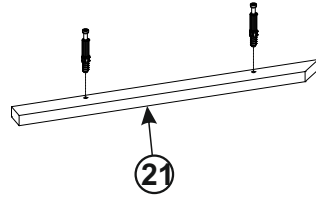
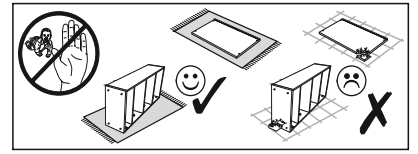
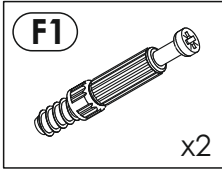

28

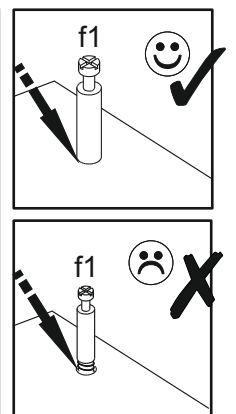
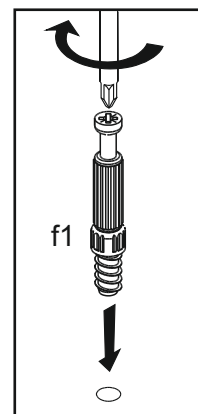
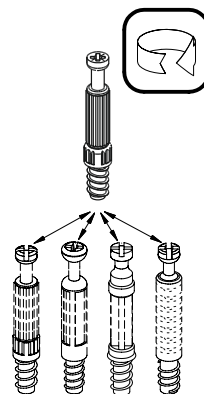
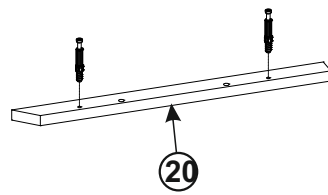
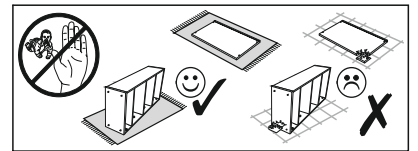
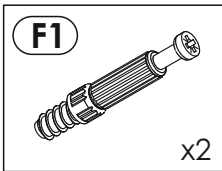

29

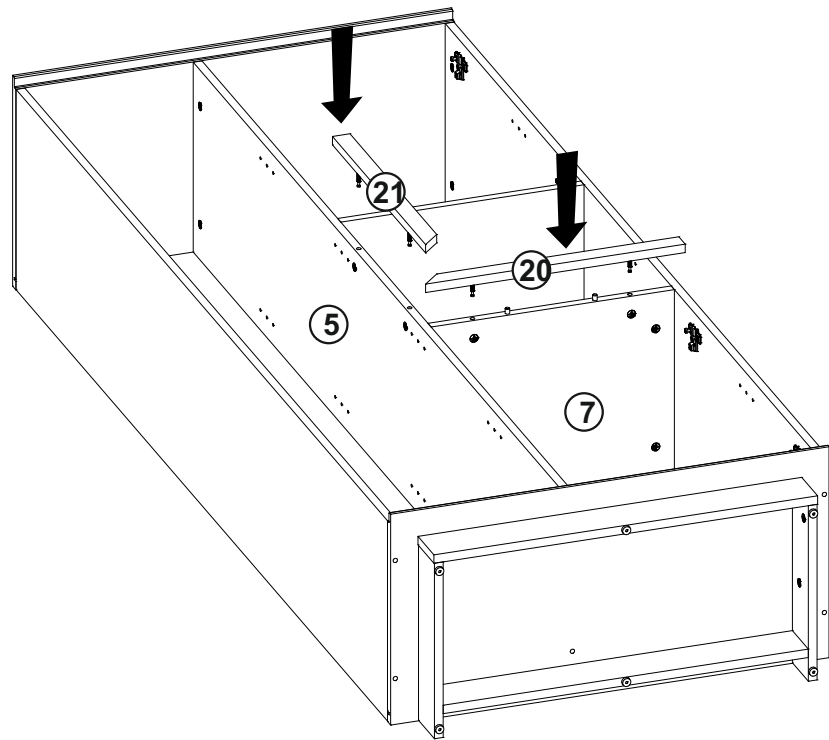
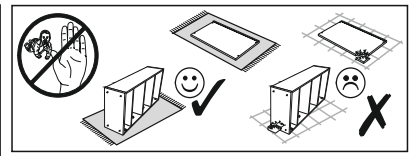
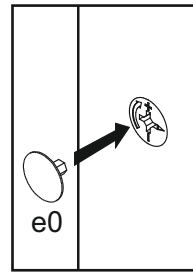
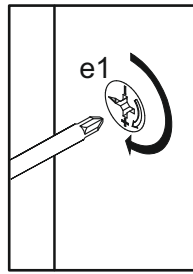
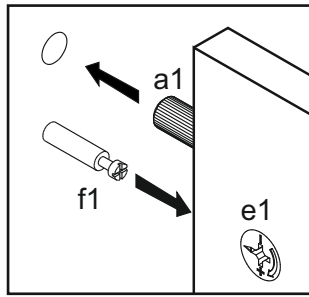
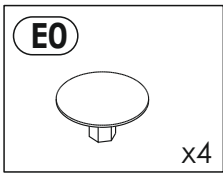

30

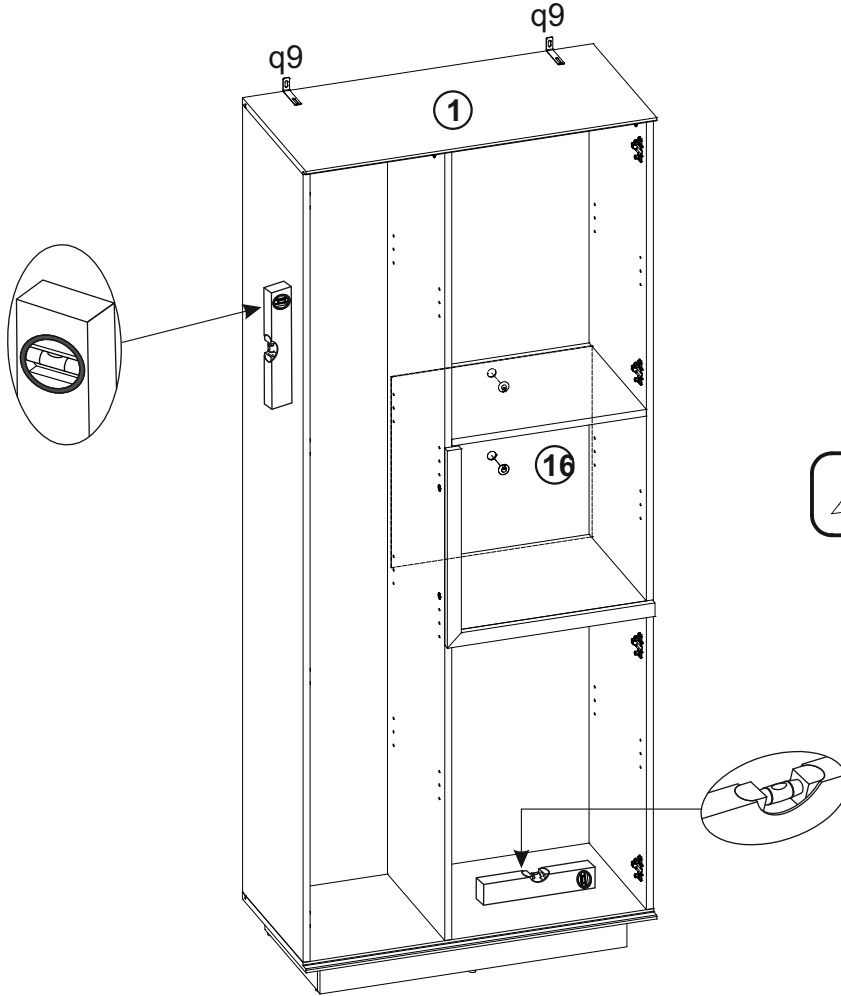
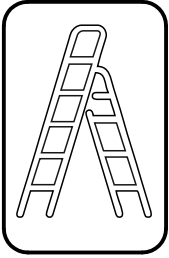
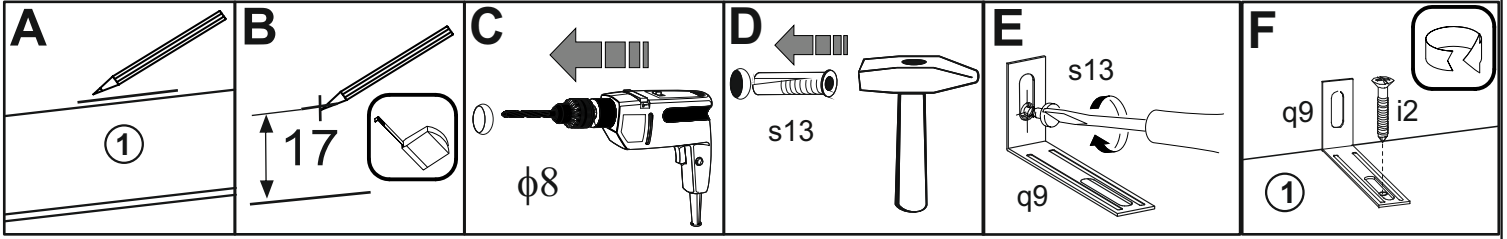
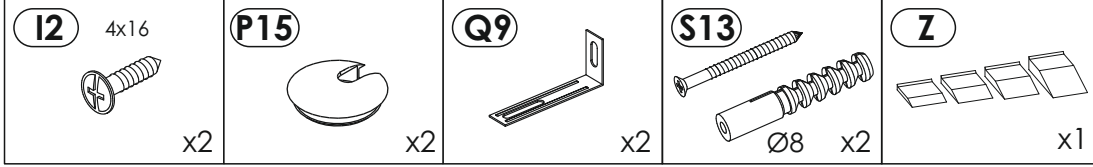

LED OPTION

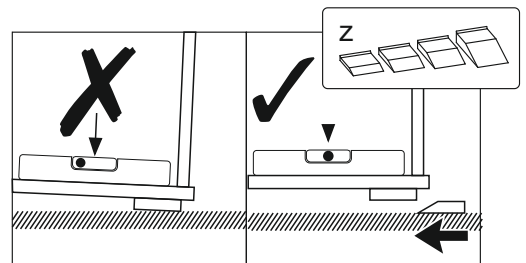
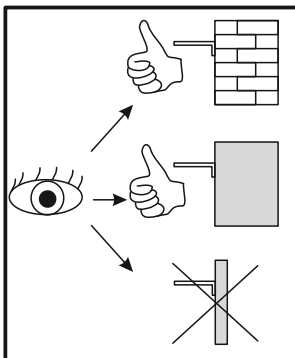
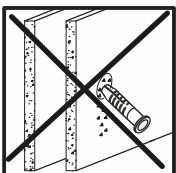
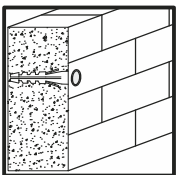
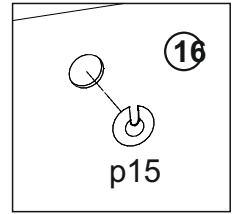
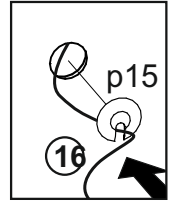

31

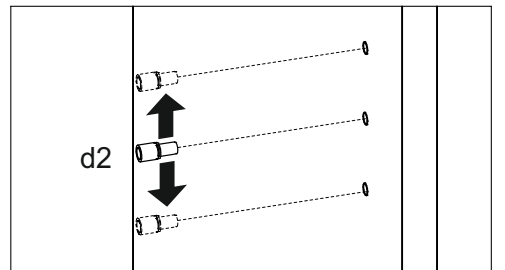
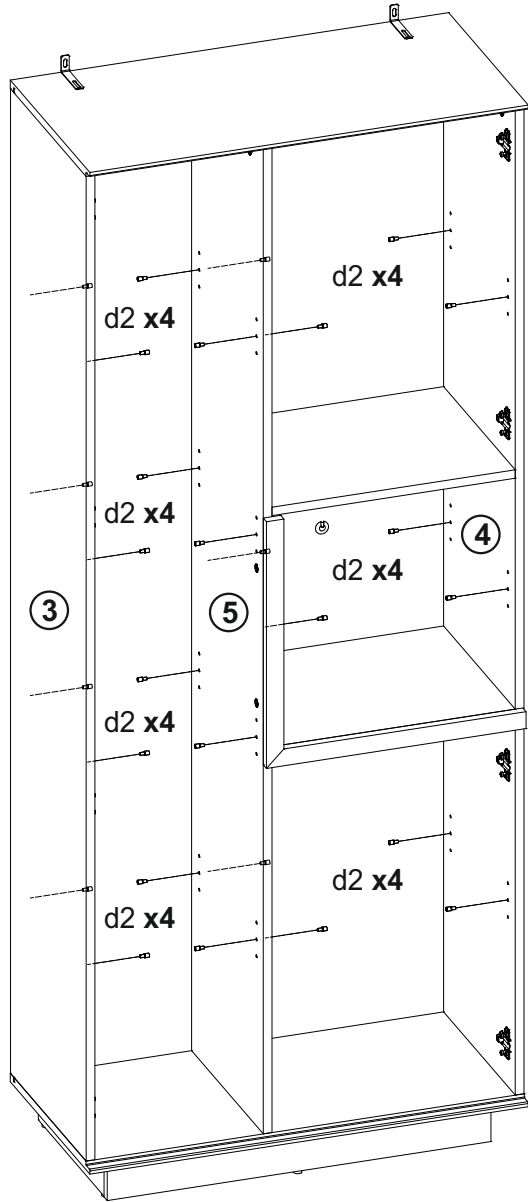
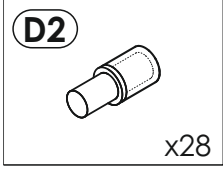

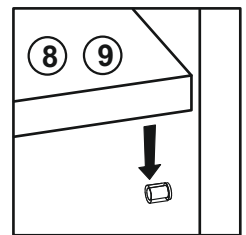
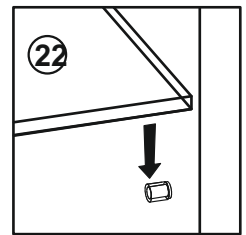
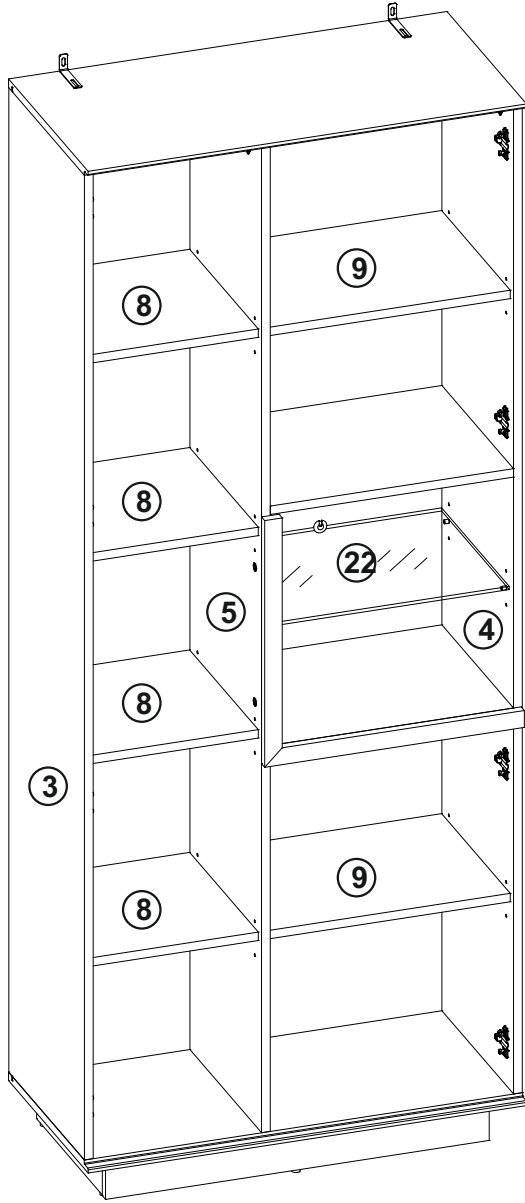

33

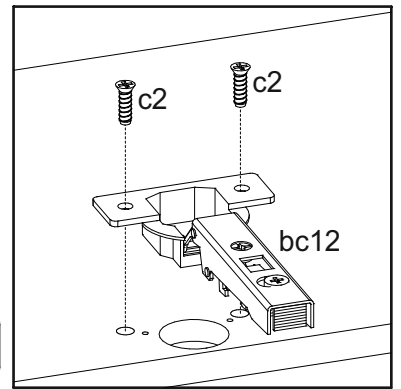
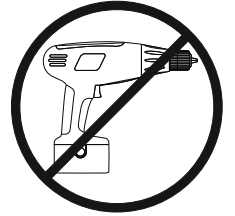
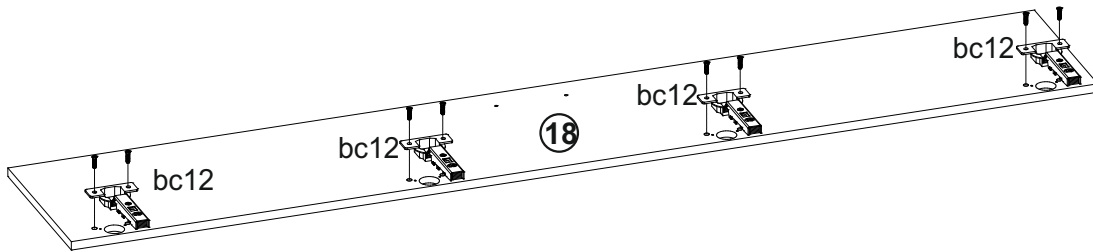
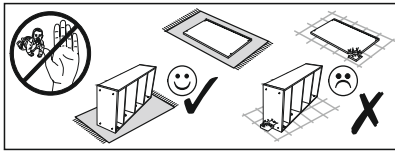
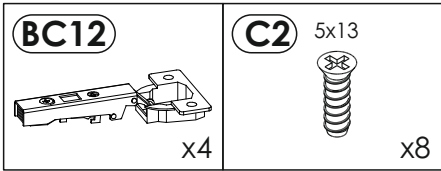

34

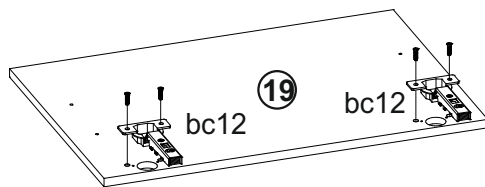
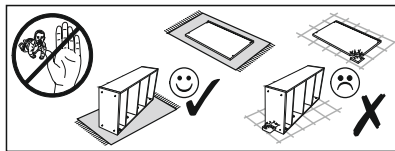
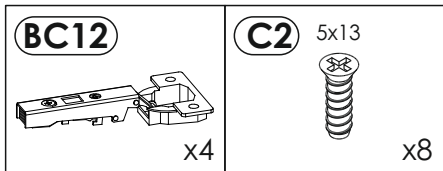

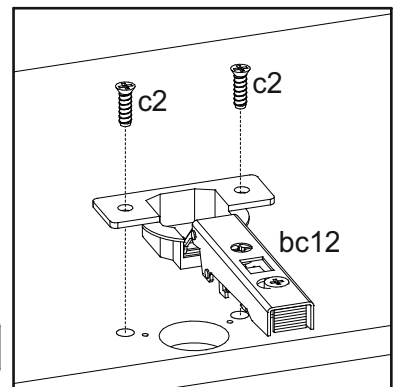
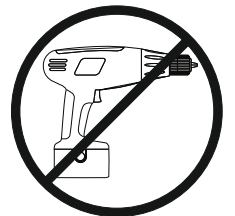

x2

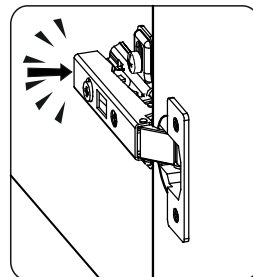
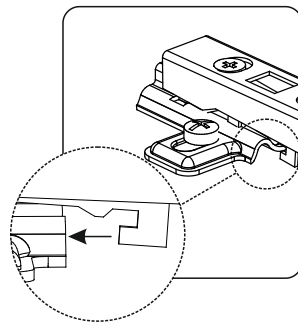
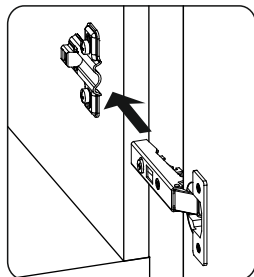
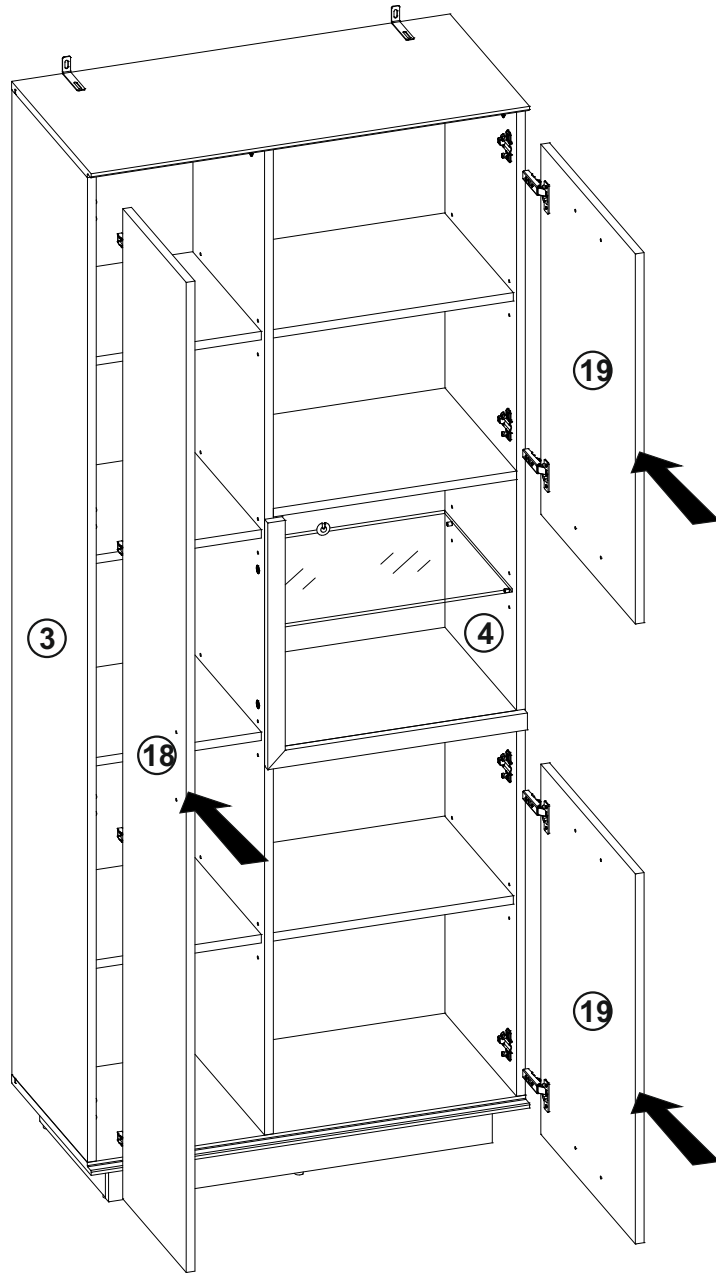
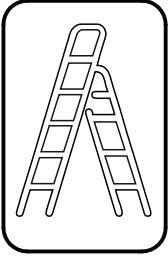



36

H1 L-180  x3	I5 3,5 x 27  x6	P0  x4
--	---	--

