

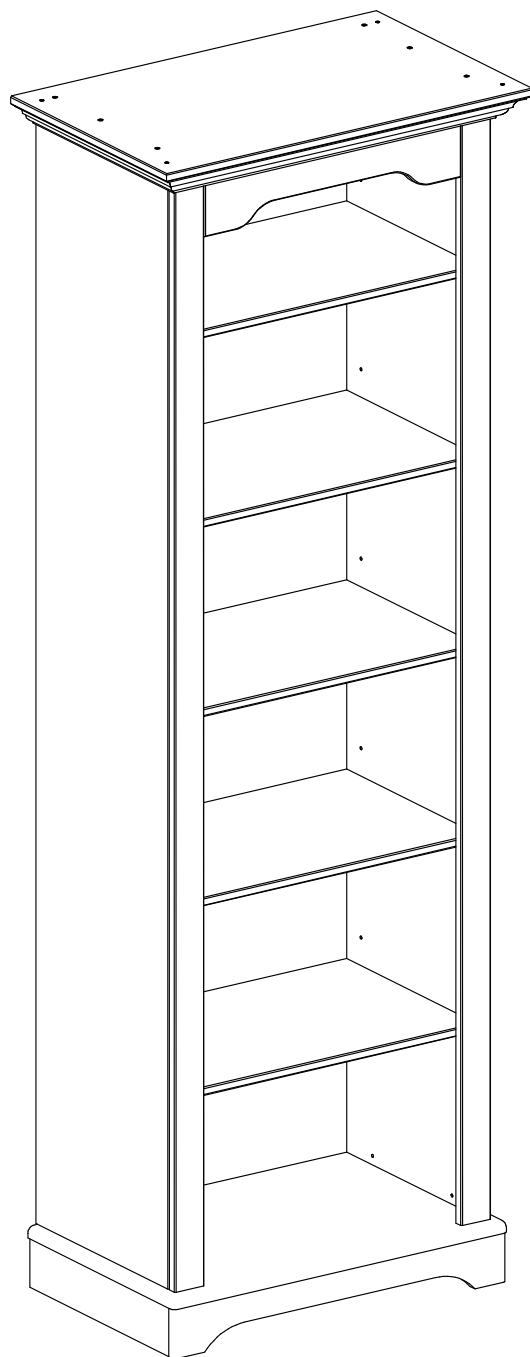

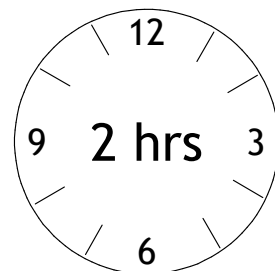

# 330145013

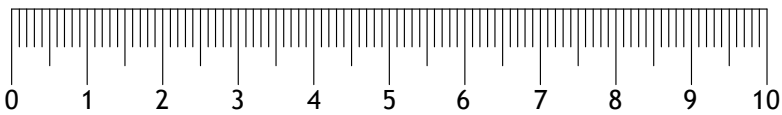

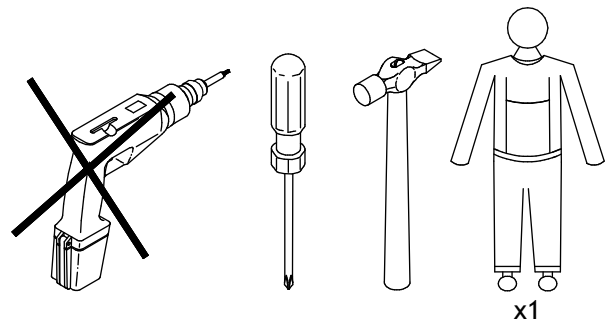
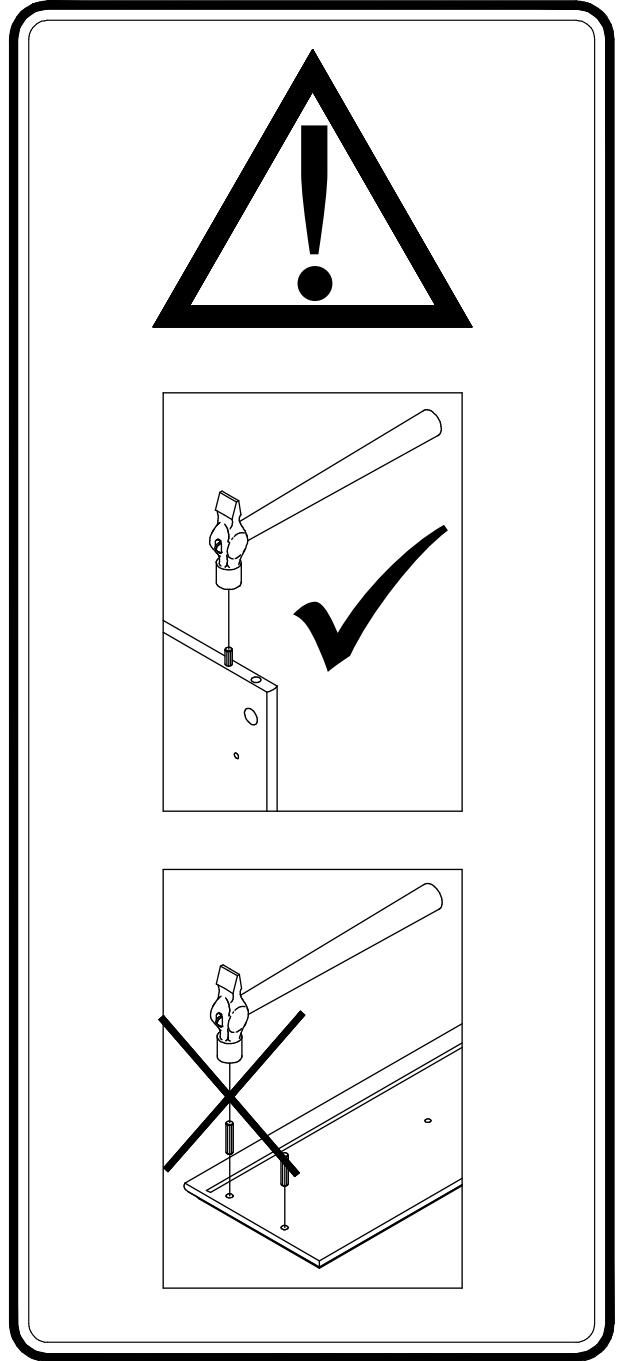
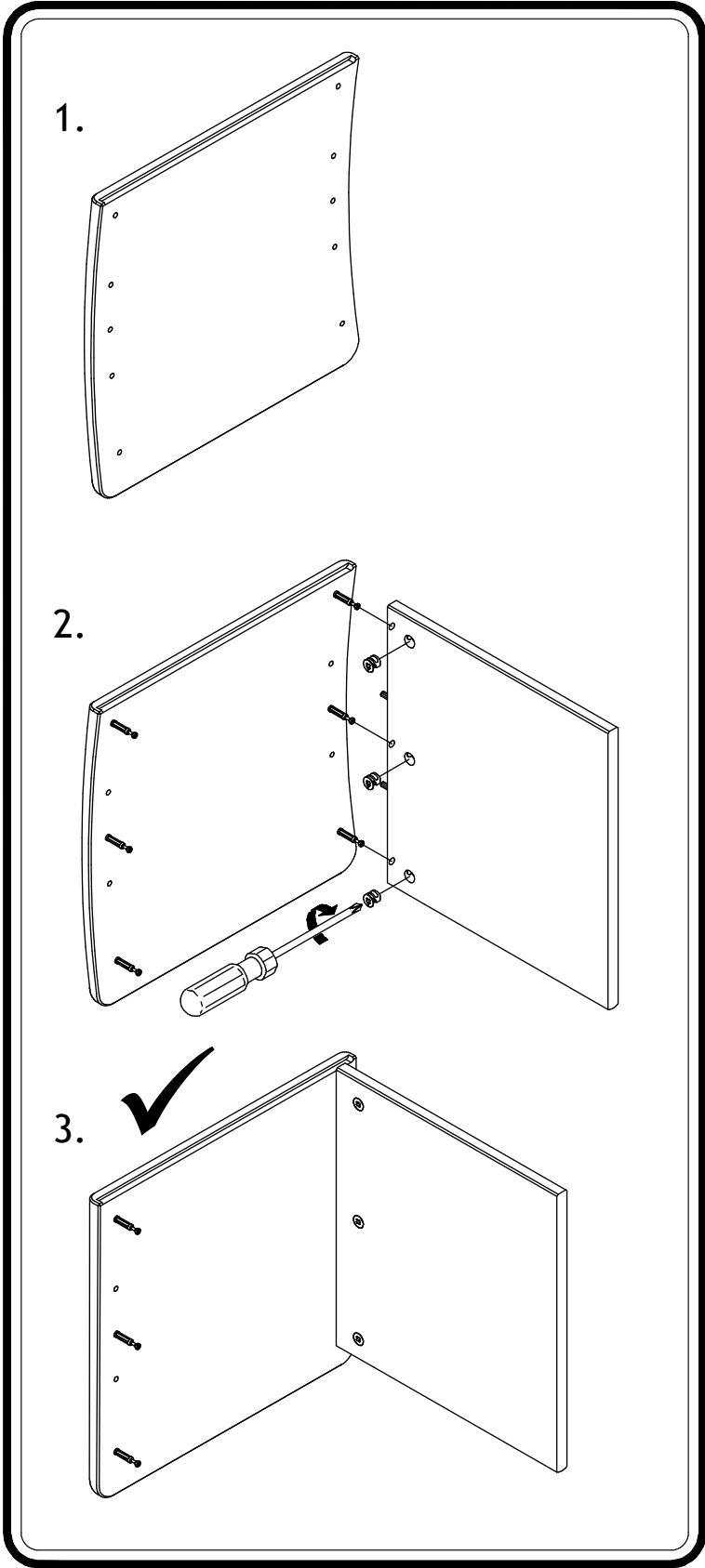
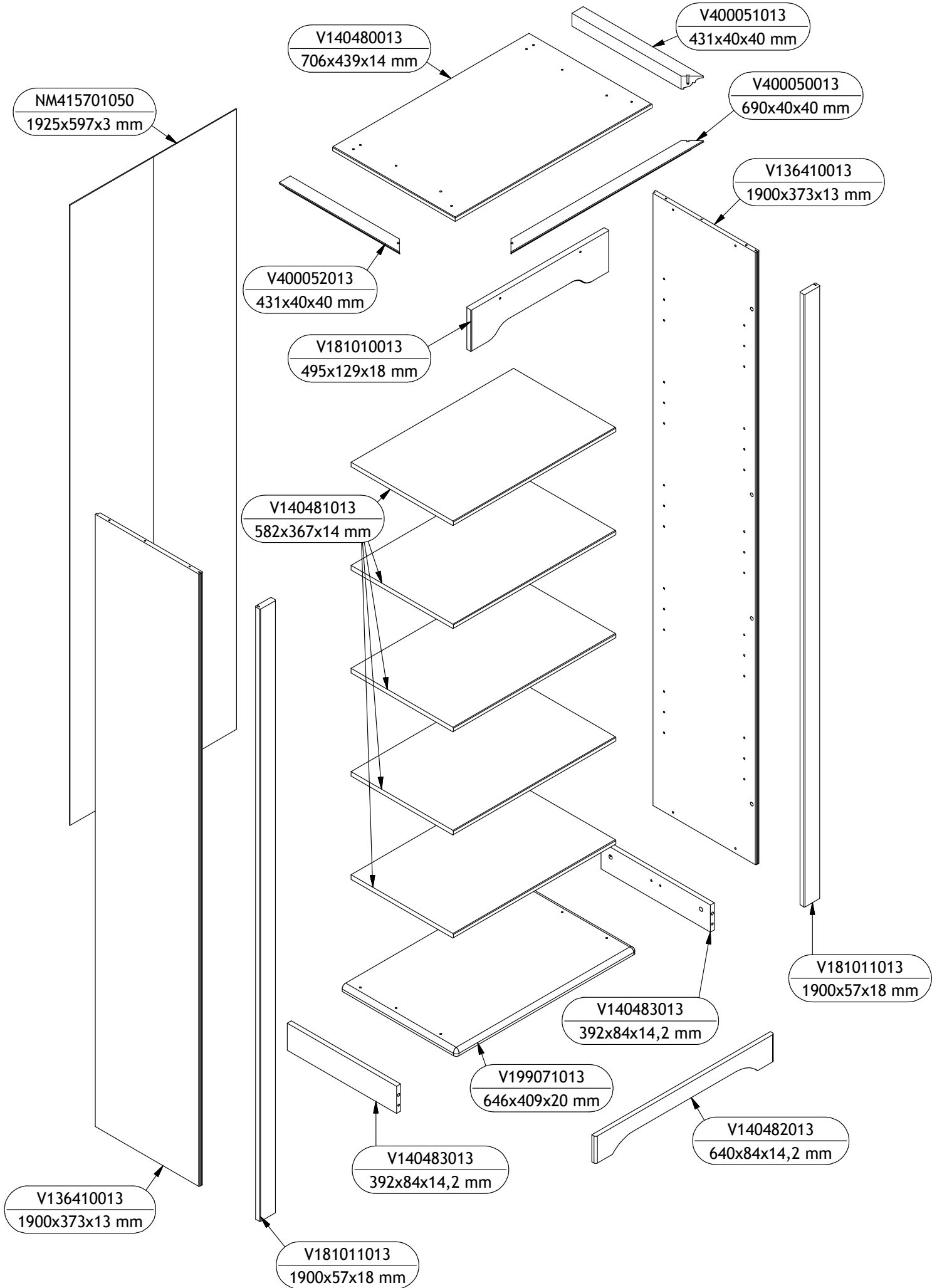
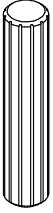
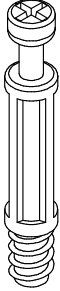
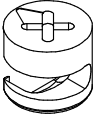
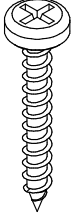
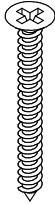

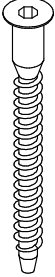
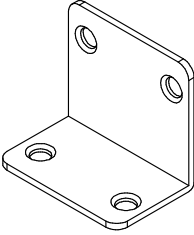
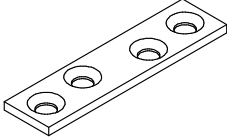
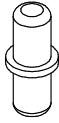
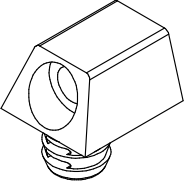
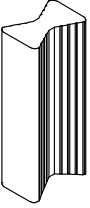
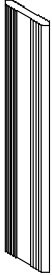

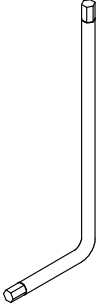
<p>BA10400 x2 ø6x30 mm</p> 	<p>BA10602 x2 5x34/8 mm</p> 	<p>BA10597 x2 ø12x10,2 mm</p> 	<p>BA10144 x8 ø4,5x30 mm</p> 	<p>BA10070 x10 ø3,5x30 mm</p> 	<p>BA10120 x4 ø3,5x12 mm</p> 
<p>BA10240 x12 ø6,1x11,5 mm</p> 	<p>BA10312 x12 ø5x50 mm</p> 	<p>BA10821 x3 45x40x29 mm</p> 	<p>BA10805 x2 50x13x2 mm</p> 	<p>BA10830 x20 5/5 mm</p> 	<p>BA10336 x8 22x12 mm</p> 
<p>BA10985 x2</p> 	<p>BA10981 x10 3x16,5x80 mm</p> 	<p>BA10025 x50 ø1,2x20 mm</p> 	<p>BA106802 x1 3 mm</p> 	<p>I10881 x1 15 g</p> 